

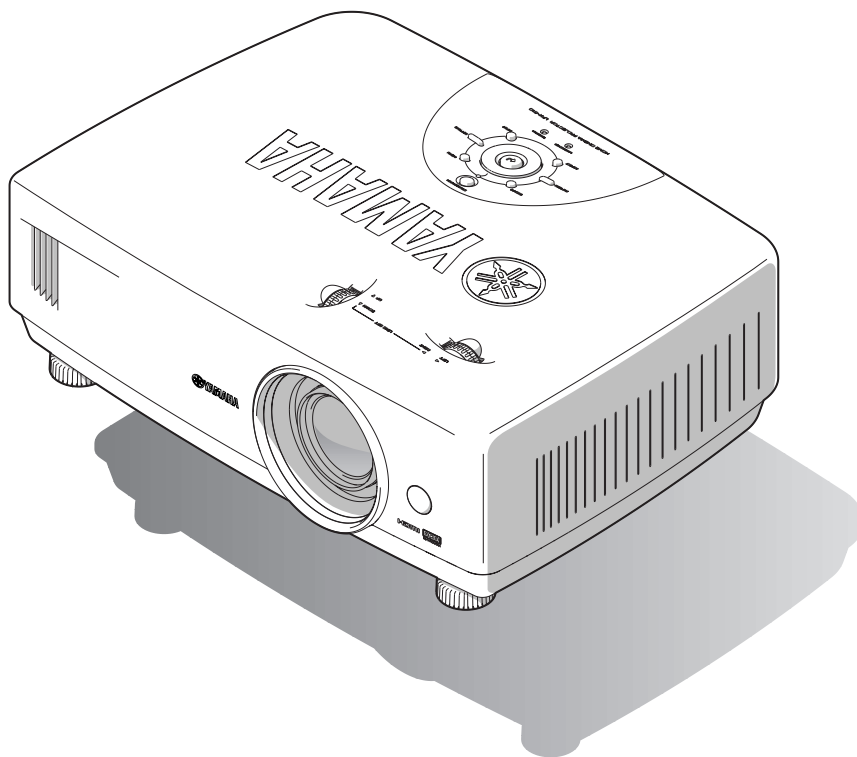

LPX-510

Home Cinema Projector

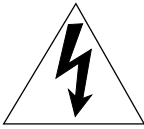

IMPORTANT SAFETY INSTRUCTIONS

	CAUTION RISK OF ELECTRIC SHOCK DO NOT OPEN	
<p>CAUTION: TO REDUCE THE RISK OF ELECTRIC SHOCK, DO NOT REMOVE COVER (OR BACK). NO USER-SERVICEABLE PARTS INSIDE. REFER SERVICING TO QUALIFIED SERVICE PERSONNEL.</p>		

• Explanation of Graphical Symbols

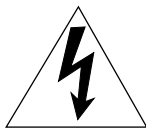

The lightning flash with arrowhead symbol, within an equilateral triangle, is intended to alert you to the presence of uninsulated “dangerous voltage” within the product’s enclosure that may be of sufficient magnitude to constitute a risk of electric shock to persons.



The exclamation point within an equilateral triangle is intended to alert you to the presence of important operating and maintenance (servicing) instructions in the literature accompanying the appliance.

WARNING

TO REDUCE THE RISK OF FIRE OR ELECTRIC SHOCK, DO NOT EXPOSE THIS UNIT TO RAIN OR MOISTURE.

IMPORTANT!

Please record the serial number of this unit in the space below.

Model:

Serial No.:

The serial number is located on the bottom of the unit.

Retain this Owner’s Manual in a safe place for future reference.

- 1 Read these instructions.
- 2 Keep these instructions.
- 3 Heed all warnings.
- 4 Follow all instructions.
- 5 Do not use this apparatus near water.
- 6 Clean only with dry cloth.
- 7 Do not block any ventilation openings. Install in accordance with the manufacturer’s instructions.
- 8 Do not install near any heat sources such as radiators, heat registers, stoves, or other apparatus (including amplifiers) that produce heat.
- 9 Do not defeat the safety purpose of the polarized or grounding-type plug. A polarized plug has two blades with one wider than the other. A grounding type plug has two blades and a third grounding prong. The wide blade or the third prong are provided for your safety. If the provided plug does not fit into your outlet, consult an electrician for replacement of the obsolete outlet.
- 10 Protect the power cord from being walked on or pinched particularly at plugs, convenience receptacles, and the point where they exit from the apparatus.
- 11 Only use attachments/accessories specified by the manufacturer.
- 12 Use only with the cart, stand, tripod, bracket, or table specified by the manufacturer, or sold with the apparatus. When a cart is used, use caution when moving the cart/apparatus combination to avoid injury from tip-over.
- 13 Unplug this apparatus during lightning storms or when unused for long periods of time.
- 14 Refer all servicing to qualified service personnel. Servicing is required when the apparatus has been damaged in any way, such as power-supply cord or plug is damaged, liquid has been spilled or objects have fallen into the apparatus, the apparatus has been exposed to rain or moisture, does not operate normally, or has been dropped.



COMPLIANCE INFORMATION STATEMENT

(DECLARATION OF CONFORMITY PROCEDURE)

Responsible Party: Yamaha Electronics Corporation
Address: 6660 Orangethorpe Avenue
Buena Park, CA90620
Telephone: 714-522-9105
Fax: 714-670-0108
Type of Equipment: Projector
Model Name: LPX-510

This device complies with Part 15 of the FCC Rules.

Operation is subject to the following conditions:

- 1) this device may not cause harmful interference, and
- 2) this device must accept any interference received including interference that may cause undesired operation.

See the user manual instructions if interference to radio reception is suspected.

FCC INFORMATION (for US customers)

1. IMPORTANT NOTICE: DO NOT MODIFY THIS UNIT!

This product, when installed as indicated in the instructions contained in this manual, meets FCC requirements. Modifications not expressly approved by Yamaha may void your authority, granted by the FCC, to use the product.

2. IMPORTANT: When connecting this product to accessories and/or another product use only high quality shielded cables. Cable/s supplied with this product **MUST** be used. Follow all installation instructions. Failure to follow instructions could void your FCC authorization to use this product in the USA.

3. NOTE: This product has been tested and found to comply with the requirements listed in FCC Regulations, Part 15 for Class “B” digital devices. Compliance with these requirements provides a reasonable level of assurance that your use of this product in a residential environment will not result in harmful interference with other electronic devices.

This equipment generates/uses radio frequencies and, if not installed and used according to the instructions found in the users manual, may cause interference harmful to the operation of other electronic devices.

Compliance with FCC regulations does not guarantee that interference will not occur in all installations. If this product is found to be the source of interference, which can be determined by turning the unit “OFF” and “ON”, please try to eliminate the problem by using one of the following measures:

Relocate either this product or the device that is being affected by the interference.

Utilize power outlets that are on different branch (circuit breaker or fuse) circuits or install AC line filter/s.

In the case of radio or TV interference, relocate/reorient the antenna. If the antenna lead-in is 300 ohm ribbon lead, change the lead-in to coaxial type cable.

If these corrective measures do not produce satisfactory results, please contact the local retailer authorized to distribute this type of product. If you can not locate the appropriate retailer, please contact Yamaha Electronics Corp., U.S.A. 6660 Orangethorpe Ave, Buena Park, CA 90620.

The above statements apply **ONLY** to those products distributed by Yamaha Corporation of America or its subsidiaries.

We Want You Listening For A Lifetime

YAMAHA and the Electronic Industries Association’s Consumer Electronics Group want you to get the most out of your equipment by playing it at a safe level. One that lets the sound come through loud and clear without annoying blaring or distortion — and, most importantly, without affecting your sensitive hearing. Since hearing damage from loud sounds is often undetectable until it is too late, YAMAHA and the Electronic Industries Association’s Consumer Electronics Group recommend you to avoid prolonged exposure from excessive volume levels.



Caution: Read this before operating this unit.

- To assure the finest performance, please read this manual carefully. Keep it in a safe place for future reference.

Installation

- Install this unit in a well-ventilated, cool, dry, clean place with at least 10 cm clearance on the top, right and left, and at the back of this unit — away from direct sunlight, heat sources, vibration, dust, moisture, and/or cold.
- Locate this unit away from other electrical appliances, motors, or transformers to avoid humming sounds. To prevent fire or electrical shock, do not place this unit where it may get exposed to rain, water, and/or any type of liquid.
- Do not expose this unit to sudden temperature changes from cold to hot, and do not locate this unit in an environment with high humidity (i.e. a room with a humidifier) to prevent condensation inside this unit, which may cause an electrical shock, fire, damage to this unit, and/or personal injury.
- On the top of this unit, do not place:
 - Other components, as they may cause damage and/or discoloration on the surface of this unit.
 - Burning objects (i.e. candles), as they may cause fire, damage to this unit, and/or personal injury.
 - Containers with liquid in them, as they may cause electrical shock to the user and/or damage to this unit.
- Do not cover this unit with a newspaper, tablecloth, curtain, etc. in order not to restrict heat dissipation. If the temperature inside this unit rises too much, it may cause fire, damage to this unit, and/or personal injury.
- When installing this unit on the ceiling, make sure the ceiling has sufficient strength to support this unit and the ceiling mounts for an extended period of time. Installation must be performed only by qualified service personnel.

Operation

- Remove the lens cap before starting any operation of this unit to prevent the heat from staying around the lens. Operation with the cap on may cause damage to this unit.
- Do not plug in this unit to a wall outlet until all connections are complete.
- Only the voltage specified on this unit must be used. Using this unit with a higher voltage than specified is dangerous and may cause fire, damage to this unit, and/or personal injury. YAMAHA will not be held responsible for any damage resulting from use of this unit with a voltage other than that specified.
- Do not use force on switches, knobs and/or cords.
- Take care of this unit so that no foreign objects and/or liquid drop inside this unit.
- To prevent damage by lightning, disconnect the power cord from the wall outlet during an electrical storm.
- Do not look into the lens while this unit is turned on. It may cause serious damage to your eyesight.
- Before moving this unit, press **STANDBY/ON** to set this unit in the standby mode, and disconnect the AC power plug from the wall outlet.
- Do not attempt to modify or fix this unit. Contact qualified YAMAHA service personnel when any service is needed. The cabinet should never be opened for any reason.

- When not planning to use this unit for a long period of time (i.e. vacation), disconnect the AC power plug from the wall outlet.
- When disconnecting the power cord from the wall outlet, grasp the plug; do not pull the cord.
- Be sure to read the “TROUBLESHOOTING” section on common operating errors before concluding that this unit is faulty.

Others

- Clean the lens carefully so as not to create any scratches by using a blower or lens paper.
- Replace the lamp when the LAMP/COVER indicator flashes in red after the lamp usage has exceeded 1600 hours. Follow the lamp replacement procedure described in this manual.

This unit is not disconnected from the AC power source as long as it is connected to the wall outlet, even if this unit itself is turned off. This state is called the standby mode. In this state, this unit is designed to consume a very small quantity of power.

For U.K. customers

- If the socket outlets in the home are not suitable for the plug supplied with this appliance, it should be cut off and an appropriate 3 pin plug fitted. For details, refer to the instructions described below.

Note

The plug severed from the mains lead must be destroyed, as a plug with bared flexible cord is hazardous if engaged in a live socket outlet.

IMPORTANT

THE WIRES IN THIS MAINS LEAD ARE COLOURED IN ACCORDANCE WITH THE FOLLOWING CODE:

GREEN-AND-YELLOW:	EARTH
BLUE:	NEUTRAL
BROWN:	LIVE

As the colours of the wires in the mains lead of this apparatus may not correspond with the coloured markings identifying the terminals in your plug, proceed as follows:
The wire which is coloured GREEN-AND-YELLOW must be connected to the terminal in the plug which is marked by the letter E or by the safety earth symbol or coloured GREEN or GREEN-and-YELLOW.
The wire which is coloured BLUE must be connected to the terminal which is marked with the letter N or coloured BLACK.
The wire which is coloured BROWN must be connected to the terminal which is marked with the letter L or coloured RED.

For Canadian Customers

To prevent electric shock, match wide blade of plug to wide slot and fully insert.

This Class B digital apparatus complies with Canadian ICES-003.

OBSERVERA

Apparaten kopplas inte bort från växelströmskällan (nätet) så länge som den är ansluten till vägguttaget, även om själva apparaten har stängts av.

ADVARSEL

Netspændingen til dette apparat er IKKE afbrudt, så længe netledningen sidder i en stikkontakt, som er tændt – også selvom der er slukket på apparatets afbryder.

VAROITUS

Laitteen toisiopiiriin kytketty käyttökytkin ei irroita koko laitetta verkosta.



Alleen voor klanten in Nederland

Bij dit product zijn batterijen geleverd. Wanneer deze leeg zijn, moet u ze niet weggooien maar inleveren als KCA.

Notations used in this Owner's Manual

Indications

	Indicates procedures where personal injury or damage to the projector may occur if the procedures are not followed correctly.
	Indicates additional information and points which may be useful to know regarding a topic.
»	Indicates that an explanation of the underlined word or words in front of this symbol appears in the glossary of terms. Refer to the "Glossary" in the "Appendices". (p.67)
[(Button name)],	Indicates buttons on the remote control or the projector's control panel. Example: [Menu]
"(Menu name)"	Indicates menu items. Example: "Image" - "Color Adjustment"

Contents

Notes on Handling and Storage	2
Accessories	3
Features of the Projector	4

Basic Operations

Turning On the Projector.....	6
Connecting the Power Cord	6
Turning On the Power and Projecting Images.....	7
Turning Off the Projector.....	9
Adjusting the Screen Image	11
Adjusting the Image Size (Zoom adjustment).....	11
Projection image position adjustment (Lens shift).....	12
Correcting Keystone Distortion (Keystone)	13
Displaying a Test Pattern.....	14
Adjusting the Image Quality.....	16
Focus adjustment.....	16
Brightness adjustment (Iris adjustment).....	17
Selecting the picture mode	18
Selecting the Image Aspect Ratio	19

Advanced Operations

Functions for Enhancing Projection	24
Description of Functions	24
Saving and Retrieving Image Quality Settings (Memory Save)	26
Using the Menu Functions	28
List of Menus	28
"Image" Menu	30
"Setup" Menu	32
"Info" Menu.....	36
"Reset" Menu	36
Using the Menus.....	37

Troubleshooting

When Having Some Trouble	42
When the Indicators Provide No Help	44
Problems relating to images	44
Problems when projection starts	48
Problems with the remote control	48

Appendices

Maintenance	50
Cleaning	50
Replacing Consumables	52
If vertical stripe interference appears in the projected images.....	56
Optional Accessories.....	58
List of Supported Signal Resolutions	59
Component Video/RGB Video.....	59
Composite Video/S-Video.....	59
Analog-RGB signals/signals input to the HDMI port.....	60
Range of compatible formats for HDMI port input signals	60
Specifications	61
Appearance	62
Part Names and Functions	63
Front/Top	63
Control Panel.....	64
Rear	65
Base	65
Remote Control	66
Glossary	67

Basic Operations →

Advanced Operations →

Troubleshooting →

Appendices →

Notes on Handling and Storage

Be sure to observe the following precautions to avoid malfunctions, operating errors or damage to the projector.

Notes on Handling and Storage

- Do not set up the projector near high-voltage electrical wires or sources of magnetic fields. These may interfere with correct operation.
- Do not touch the lens with bare hands. If fingerprints or grease get onto the lens, it can interfere with the quality of the projected images. Attach the lens cover to the lens when the projector is not in use.
- During projection, some points (dots) may appear lit at all times, or they may be dark at all times. This is caused by the characteristics of the LCD panel, and is not a sign of a malfunction. The LCD panel is manufactured using extremely high-precision technology. However, black dots may appear on the panel, or some red, blue or green dots may light extremely brightly at times. Furthermore, sometimes stripe-shaped color irregularities or brightness irregularities may also appear.
- Remove the batteries from the remote control before storage. If the batteries are left in the remote control for long periods, they may leak.
- Always attach the lens cap to the lens when not using the projector, to prevent the lens from becoming dirty or damaged.
- The mercury lamp that is used as the light source for the projector deteriorates as a result of impacts or damage, and also naturally over time as it is used. It may explode with a loud noise or stop illuminating, or the flickering may increase or illumination may stop, and these indicate the end of the lamp's operating life. At such times, the amount of time remaining before the lamp breaks or stops working may vary greatly depending on the individual lamp characteristics and the operating environment. These are normal characteristics of mercury lamps. You should always have a spare lamp ready in case it is needed.
- YAMAHA takes no responsibility for loss or damage caused by damage to the projector or operating failures outside normal service warranty conditions.

Lamp Operating Errors

The mercury lamp that is used as the light source for this projector may stop operating on occasions. This is a normal characteristic of mercury lamps. If the lamp does not turn on when the projector's power is turned on, remove the lamp and check if it is broken. If the lamp is not broken, reinstall it. Refer to "Replacing the Lamp" on page 53 of this manual for instruction on removing and reinstalling the lamp.

If the lamp is broken, replace it with a new lamp. It is recommended that you have a spare lamp ready at all times in case it is needed.

Notes on Carrying the Projector

- Turn off the projector power and then disconnect the power cord from the electrical outlet. Furthermore, check that all other cables have been disconnected.
- Attach the lens cap to the lens.
- Retract the adjustable foot.

Notes when transporting the projector

When packing up the projector in its container for transportation, use the lens shift function to lower the lens fully.

Accessories

Check the included accessories

Remote control

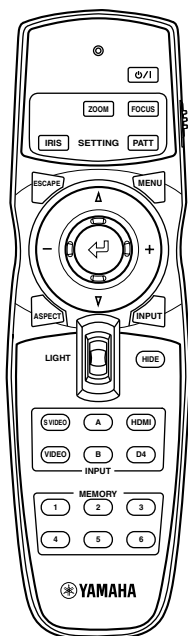

Setup guide

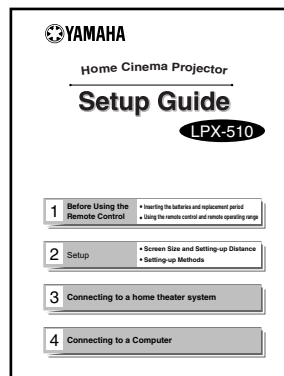

Battery (AA) x 2

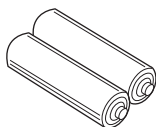

Power cord

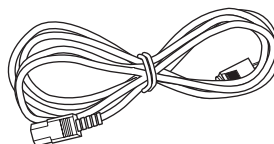

* The shape of the power cord will vary depending on the market destination.

Lens cap

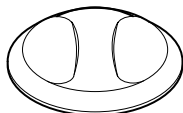

Trigger-out DC plug
(for USA only)



When not using the projector, always be sure to attach the lens cap in order to protect the lens.

Features of the Projector

▶ Image appearance can be selected to match the projection environment (Picture Mode)

The projector is equipped with a unique CB (color balance) filter that enhances the color reproduction of images.

It is ideal for use in providing the optimum image effects for the projection environment when viewing images such as games, sporting competitions and movies. It makes other troublesome color adjustments unnecessary. (p.18)

▶ Equipped with a wide-angle lens shift function

The lens shift function allows you to adjust the position of the projected images vertically and horizontally without distorting the images. This allows the projector to be set up with greater freedom, even if it is suspended from a ceiling or at an angle to the screen. (p.12)

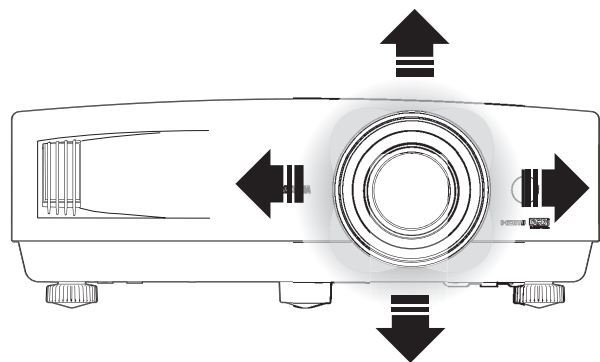

▶ Wide range of brightness adjustments

The image brightness can be adjusted within a wide range. Optimum images can be obtained even if using the projector in a bright environment for watching videos or games, or in a dark environment such as when creating the atmosphere of a home theatre. (p.30)

▶ Electronic zoom and focus adjustment

The projector's control panel and the accessory remote control can be used for easy zoom and focus adjustments.

For zoom adjustment, a high magnification lens is provided to allow images to be increased in size by up to 1.5 times, so that images can be projected onto an 80" screen even at a distance of approximately 2.5 m (8.2 ft.). (p.11, 16)

▶ A variety of image setting functions

Many other functions are available as follows.

- Progressive and Motion Detection functions allow you to obtain ideal results both for images with large amounts of movement and for still images. (p.32)
- An aspect function that allows images to be viewed in wide-screen format. (p.19)
- Memory functions that allow adjustment results to be stored and later retrieved easily using the remote control. (p.26)
- Key lock function that locks the control panel so that settings cannot be changed accidentally after adjustment. (p.34)
- Adoption of a special high-resolution DCDi video circuit developed by Faroudja. This circuit greatly reduces the jagged edges that resulted from conventional progressive conversion. (p.32)

Basic Operations

This chapter describes basic operations such as turning the projector on and off and adjusting the projected images.

Turning On the Projector	6
• Connecting the Power Cord	6
• Turning On the Power and Projecting Images	7
Turning Off the Projector	9
Adjusting the Screen Image	11
• Adjusting the Image Size (Zoom adjustment)	11
• Projection image position adjustment (Lens shift)	12
• Correcting Keystone Distortion (Keystone)	13
• Displaying a Test Pattern	14
Adjusting the Image Quality	16
• Focus adjustment	16
• Brightness adjustment (Iris adjustment)	17
• Selecting the picture mode	18
• Selecting the Image Aspect Ratio	19
• Normal mode	20
• Squeeze mode	20
• Zoom mode	20
• Smart Zoom mode	21
• Through mode	21
• Squeeze Through mode	21

Turning On the Projector

This section describes the procedure from turning on the power to projecting images.



Be sure to read the *Safety Instructions* in this manual for details on safe handling when using the projector.

Connecting the Power Cord

1

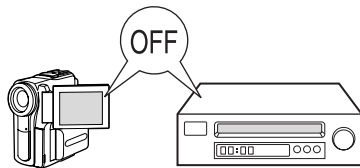

Check that the power is turned off for all components connected to the projector.

2

Connect the computer or other video source to the projector.

Refer to the *Setup Guide*.

3

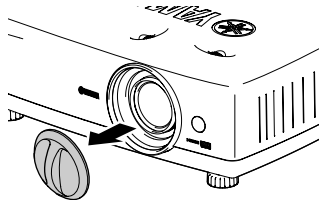

Remove the lens cap.

4

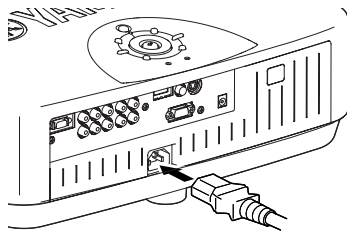

Connect the accessory power cord to the projector.

Check that the power cord connector is facing the same way as the power inlet on the projector, and then insert the power cord connector securely into the projector.

5

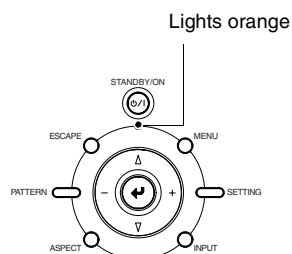

Connect the other end of the power cord to a grounded electrical outlet.

The $\text{O} / |$ indicator will light orange and the projector will switch to standby mode.

Turning On the Power and Projecting Images

1

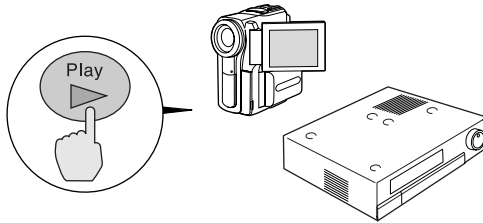

Turn on the power for all equipment connected to the projector.

For a video source, press the [Play] button at the video source to start playback.

2

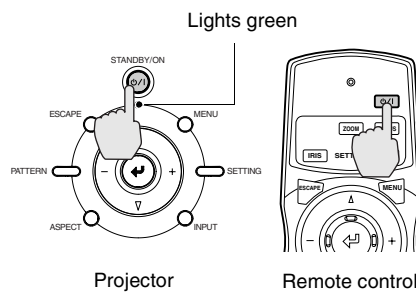

Press the [STANDBY/ON] button on the projector's control panel or the  button on the remote control to turn on the power.

The  indicator flashes green, and after a short period projection starts.







Check that the  indicator has stopped flashing and lights green.





The buttons on the remote control and the projector's control panel cannot be operated while the  indicator is flashing green. Wait until it lights steadily.

3



If more than one signal source has been connected or the images are not being projected, use the remote control or control panel buttons to select the signal source.

Port	Button to press		Display at top-right of screen
	Projector or remote control	Remote control	
INPUT A	[INPUT] or 		INPUT A (Component) or INPUT A (RGB TV) , INPUT A (RGB PC)
INPUT B			INPUT B (Component) or INPUT B (RGB TV) , INPUT B (RGB PC)
S VIDEO			S-Video
VIDEO			Video
D4 VIDEO			D4 (Component)
HDMI			HDMI (Component) , HDMI (RGB TV) , HDMI (RGB PC)

Source	
Input A	
Input B	
S-Video	
Video	
D4	
HDMI	

If you press the [INPUT] button on the projector's control panel or the  button on the remote control, the selection menu will be displayed.

If you select "INPUT A" or "INPUT B", a menu for selecting the signal format will be displayed. Select the format which matches the video signals from the connected equipment.

If using the remote control, the signal format changes in the following order each time the  or  button is pressed.

Component → RGB TV → RGB PC



- If only one signal source has been connected, the signals from that source will be projected without needing to press one of the above buttons.
- If video signals are being input to several input ports simultaneously, interference between the various signals may occur, and this may cause interference in the projected images. If this happens, turn off the power supply or disconnect the video equipment which is not currently being used.
- If the "No Signal." message does not disappear, check the connections again. No images will be projected during the time that it takes for signals to be input from the video source.
- If a laptop computer or a computer with an LCD screen has been connected to the projector, the images may not be projected straight away. After making the connections, check that the computer has been set up to output signals. The following table shows examples of how to toggle output settings. For details, refer to the section of the documentation provided with your computer under a heading such as "External output", "Connecting an external monitor" or similar.

NEC	Panasonic	Toshiba	IBM	Sony	Fujitsu	Macintosh
[Fn]+[F3]	[Fn]+[F3]	[Fn]+[F5]	[Fn]+[F7]	[Fn]+[F7]	[Fn]+[F10]	After startup, change the Control Panel adjustments so that Mirroring is active.

Turning Off the Projector

Follow the procedure below to turn off the power of the projector.

- 1**

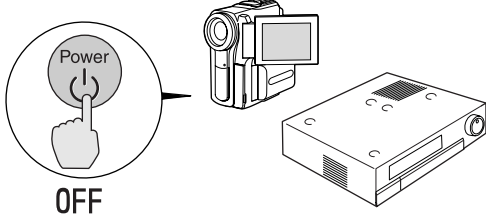

Turn off the power for the signal sources that are connected to the projector.

Check that the power for all connected components has been tuned off.
- 2**

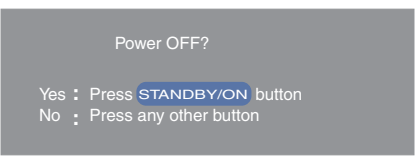



Press the [STANDBY/ON] button on the projector's control panel or the  button on the remote control.

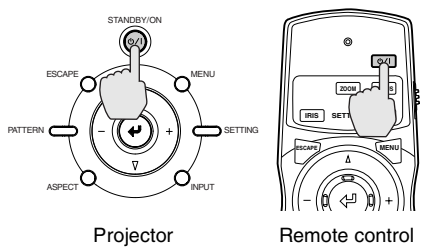

The confirmation message shown at left will appear.

If you do not want to turn off the power, press any button except the [STANDBY/ON] button.

If you do not carry out any operation, the message will disappear after seven seconds. (The power will not turn off at this time.)
- 3**



Press the [STANDBY/ON] button on the projector's control panel or the  button on the remote control once more.

The lamp will switch off, the  indicator will flash orange and **cool-down**  will start.

The remote control and the projector's control panel cannot be operated while cool-down is in progress (about 30 seconds).

After cool-down is complete, the  indicator will change to lit orange (standby mode).
- 4**

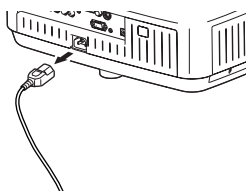

If not using the projector for long periods of time, disconnect the power cord plug from the wall outlet.

Always make sure that the projector is in standby mode before disconnecting the power cord.

The  indicator will continue to light for a short period after the power cord is disconnected, and then it will turn off.



Do not disconnect the power cord while the projector is projecting or while cool-down is in progress. If the power cord is disconnected at times such as when projection is in progress, wait for the lamp to cool down (normally about one hour is required) before turning the power back on again. If the power is turned off and on before the lamp has cooled down, it may result in lamp operating errors. Refer to "Lamp operating error" on page 42.

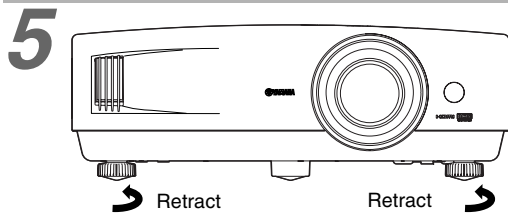

Retract the front adjustable foot if it is extended.

Turn the front adjustable foot to retract it.

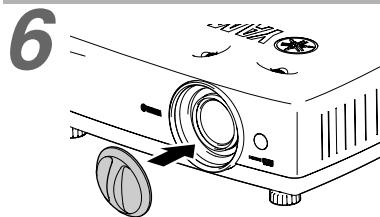

Attach the lens cap.

Attach the lens cap to the lens when not using the projector, in order to stop the lens from getting dusty or dirty.

7

Disconnect the cords that are connecting the projector and other equipment.

Adjusting the Screen Image

You can adjust the screen image in order to obtain the best possible picture.

Adjusting the Image Size (Zoom adjustment)

The size of the projected image is basically determined by the distance from the projector to the screen.
(Refer to the *Setup Guide*.)

The following procedures explain how to adjust the screen image once the projector itself has been set up.

1

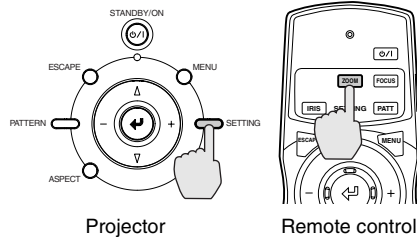

Press the [SETTING] button on the projector's control panel or the **ZOOM** button on the remote control.

An adjustment icon will be displayed over the image during projection.

The adjustment mode changes as follows each time the [SETTING] button on the projector's control panel is pressed.

Zoom → Focus → Iris

2

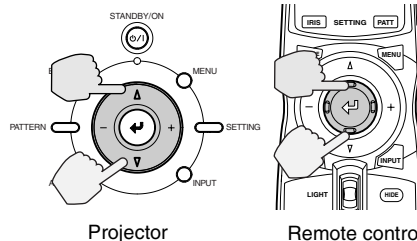

Adjust the image size.

If using the projector's control panel, press the Δ or ∇ button to adjust the image size.

If using the remote control, tilt the \curvearrowright button to adjust the image size.

Adjustment is also possible while a test pattern is being projected. (p.14)

3

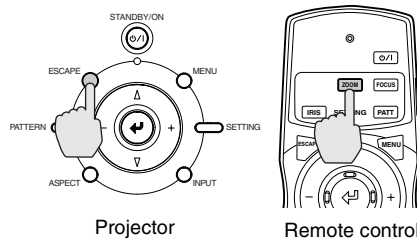

Exit adjustment mode.

Press the [ESCAPE] button on the projector's control panel or the **ZOOM** button on the remote control.



When the electronic zoom lock is set to "ON", the projection size cannot be adjusted.

The  symbol will be displayed at this time. To carry out adjustments, change the electronic zoom lock setting to "OFF". (p.34)

Projection image position adjustment (Lens shift)

The lens shift function can be used to adjust the position of projected images when the projector has been set up in places such as the following.

- When the projector is suspended from a ceiling
- When the screen is higher than the projector
- When the projector is at an angle to the screen so that people can sit directly in front to view the screen
- When the projector is on top of a desk or similar

The lens shift function can move the lens horizontally and vertically to adjust the image position without causing keystone distortion. Use the two lens shift dials to adjust the position of the projected images.

* At the time of shipment from the factory, the vertical lens shift position is set to the lowest position, so move it to the center position before carrying out adjustment.

Horizontal lens shift: The projector can be set up anywhere between the left and right edges of the screen.

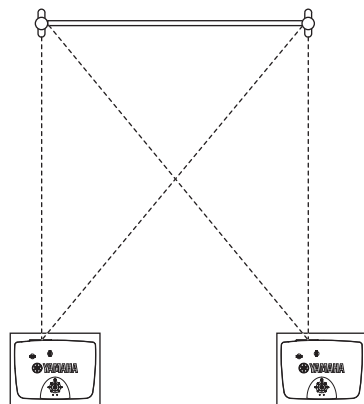

Lens at maximum right
(Can be shifted by a maximum of half the screen width)

Lens at maximum left
(Can be shifted by a maximum of half the screen width)

Vertical lens shift: The projector can be set up anywhere from the top edge of the screen to half the height of the screen below the bottom edge.

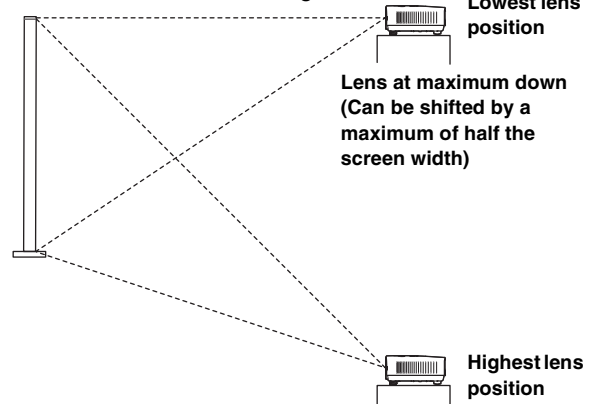

Lowest lens position

Lens at maximum down
(Can be shifted by a maximum of half the screen width)

Highest lens position

Lens at maximum up
(Can be shifted by a maximum of one screen width)

* The dotted lines indicate the projection range from the lens center position.

* The lens cannot be shifted to the maximum vertical and horizontal positions at the same time.

Adjustment procedure

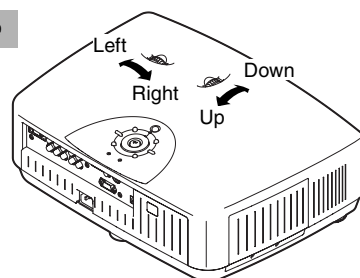

Turn the two lens shift dials to adjust.

When the lens shift dial is turned, a point of resistance will be felt. This indicates the approximate center point for the range of adjustment. In addition, if the lens shift dial becomes hard to turn further and the image position stops changing, no further adjustment is possible.

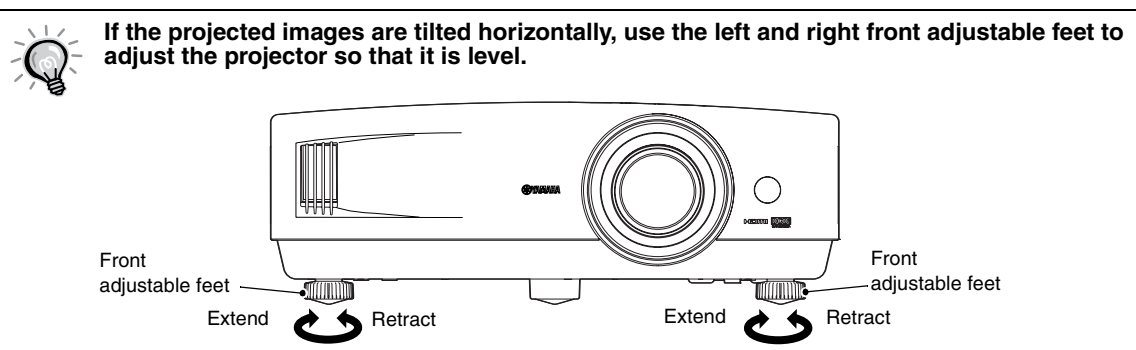

Correcting Keystone Distortion (Keystone)

When you wish to adjust the projection above or below the range of lens shift adjustment set the projector at an angle.

When the projector is angled, the projected image may distort into a trapezoid.

Keystone distortion can be corrected within a maximum vertical angle of approximately 15°.

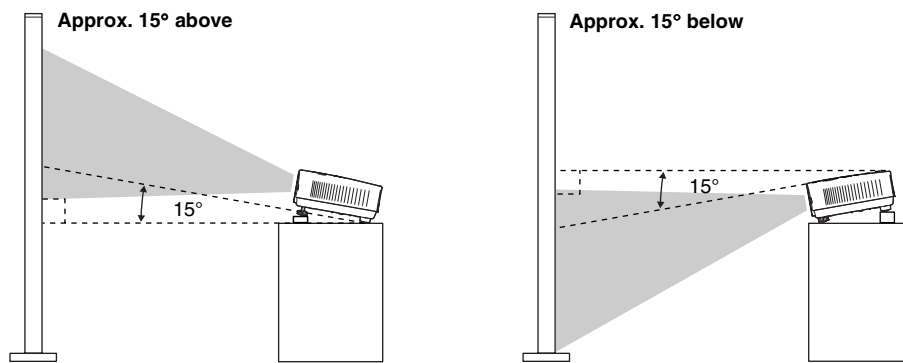

Adjustment procedure

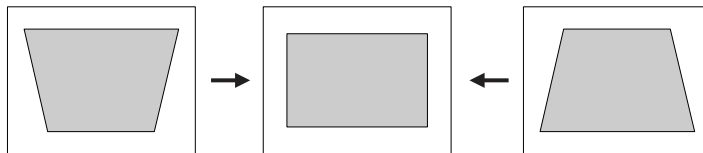

Press the Δ or ∇ button on the projector's control panel to adjust.

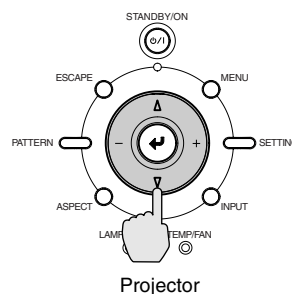
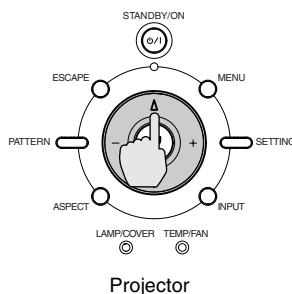

- The image quality will be lower than if the lens shift function is used.
- When the lens is shifted to the left or right, complete keystone correction is not possible. When making keystone corrections set the lens at the center left to right.
- When keystone correction is carried out, the projected image will become smaller.
- The keystone correction settings are memorized, so that if you change the position or angle of the projector, you may need to readjust the keystone correction settings.
- If the images become uneven in appearance after keystone correction is carried out, decrease the "Sharpness" setting. (p.30)
- Keystone correction can also be carried out using the projector menu. (p.33)
- If the value displayed in the gauge on the screen stops changing when horizontal or vertical keystone correction is being carried out, it indicates that the limit for horizontal or vertical keystone correction has been exceeded. Check that the projector has not been set up at an angle which exceeds the proper limit.

Displaying a Test Pattern

You can project a test pattern at times such as when setting up the projector in order to correct keystone correction and to make line menu adjustments.

- Crosshatch

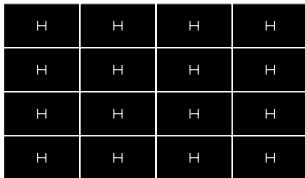

This can be used to check whether the projector is tilted or set up vertically in front of the screen.

- Grayscale pattern

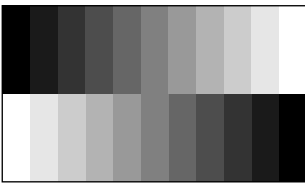

This is used when adjusting brightness or when adjusting image quality or color tone.

The adjustment is made using the line menu. Adjustments other than brightness are not possible when no image signals are being input.

1

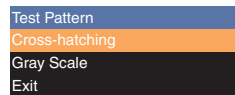

Press the [PATTERN] button on the projector's control panel or the **PATT** button on the remote control.

A pattern select menu will be displayed.

2

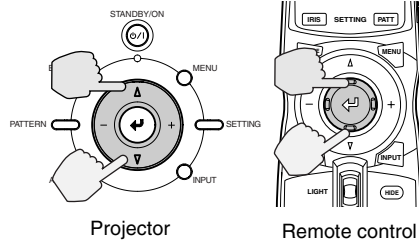

Select a pattern.

If using the projector's control panel, press the Δ or ∇ button.

If using the remote control, tilt the \odot button vertically.

3

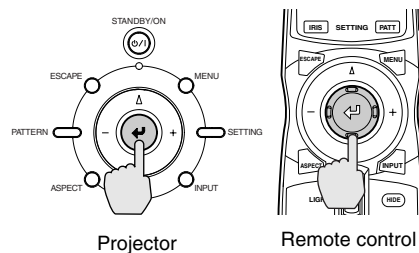



Confirm the pattern selection.

Press the \odot button on the projector's control panel or the \odot button on the remote control.

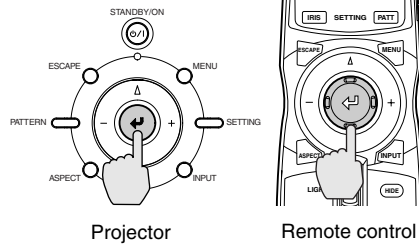

4

**Exit the pattern display.**

Display the pattern select menu and then select "Exit".

Press the  button on the projector's control panel or the  button on the remote control.



The full menu cannot be displayed while a test pattern is being projected. If setting is required, press the  button on the projector's control panel or the  button on the remote control to display the line menu, and then make the setting.

If correcting keystone distortion while a test pattern is being projected, press the Δ or ∇ button on the projector's control panel to make the setting. The remote control cannot be used for making this setting.

Adjusting the Image Quality

The quality of the screen images can be adjusted as follows.

Focus adjustment

1

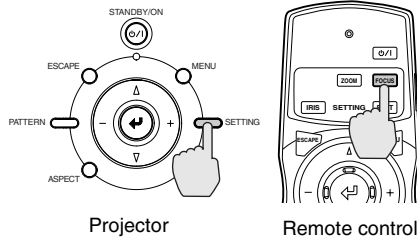

Press the [SETTING] button on the projector's control panel or the **FOCUS** button on the remote control.

An adjustment icon will be displayed over the image during projection.

The adjustment mode changes as follows each time the [SETTING] button on the projector's control panel is pressed.

Zoom → Focus → Iris

2

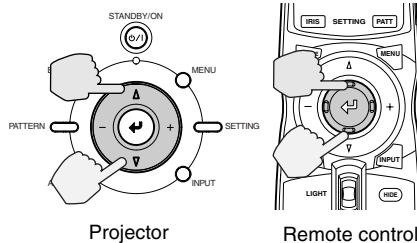

Adjust the focus.

If using the projector's control panel, press the Δ or ∇ button to adjust the image size.
If using the remote control, tilt the \odot button to adjust the image size.

Adjustment is also possible while a test pattern is being projected.

3

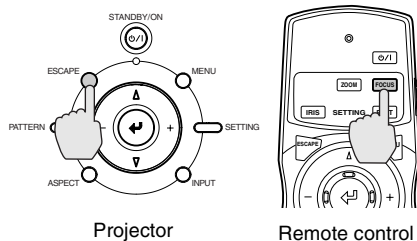

Exit adjustment mode.

Press the [ESCAPE] button on the projector's control panel or the **FOCUS** button on the remote control.



When the electronic focus lock is set to "ON", the projection size cannot be adjusted.

The \mathcal{L} symbol will be displayed at this time. To carry out adjustments, change the focus lock setting to "OFF". (p.34)

Brightness adjustment (Iris adjustment)

The brightness of the images can be adjusted.

When projecting in dark rooms or onto small screens and the images appear too bright, decrease the setting.

1

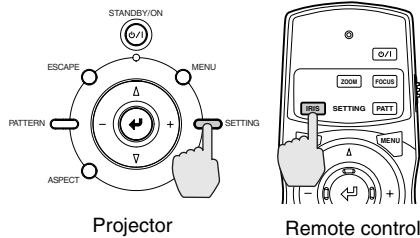

Press the [SETTING] button on the projector's control panel or the **IRIS** button on the remote control.

The line menu will be displayed over the images that are being projected.

The adjustment mode changes as follows each time the [SETTING] button on the projector's control panel is pressed.

Zoom → Focus → Iris

2

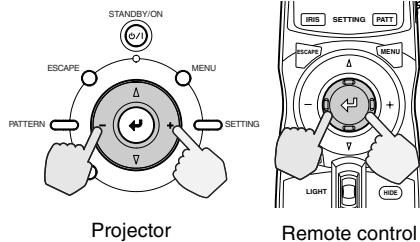

Select a setting value.

If using the projector's control panel, press the - or + button.

If using the remote control, tilt the **IRIS** button horizontally.

Adjustment is also possible while a test pattern is being projected.

3

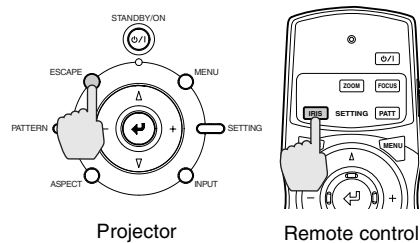

Exit adjustment mode.

Press the [ESCAPE] button on the projector's control panel or the **IRIS** button on the remote control.



The Lamp Power menu can also be used to make the adjustment. (p.34)

Selecting the picture mode

The following six picture modes have been preset for use with images with varying characteristics. Use the select menu to select a picture mode that best suits the images.

Mode name	Use
Dynamic	Ideal for viewing games and sporting competitions in bright rooms.
Bright	Ideal for viewing movies in bright rooms.
Standard	Ideal for viewing in dark rooms. It is recommended that you use this mode when making color adjustments.
Cinema	Ideal for watching movies in dark rooms.
Cinema Black	Ideal for watching movies in rooms that are completely shaded.
PC	This mode is ideal for playing back sRGB-compliant images such as those from a computer.

The default settings for each mode are given below.

Mode name	CB Filter	Gamma	Abs. Color Temp. (default value)	Iris (default value)	Flesh Tone (default value)	Lamp Power
Dynamic	OFF	-	7000k	100	5	100
Bright	OFF	-	7000k	100	5	100
Standard	ON	2.2X (basic)	6500k	100	3	75
Cinema	ON	-	6500k	100	3	75
Cinema Black	ON	-	6500k	75	3	75
PC	ON	2.2X (fixed)	6500k	100	3	75

* The CB (color balance) filter is fixed for each mode.

* If the picture mode is set to "PC", then the "Gamma", "Abs. Color Temp." and "Flesh Tone" settings cannot be adjusted.

1

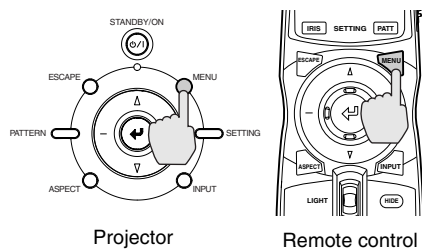

Press the [MENU] button on the projector's control panel or the button on the remote control.

The menu will be displayed.

Select "Image" - "Picture Mode".

2

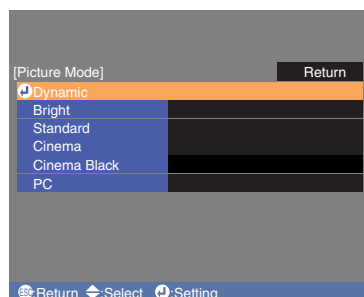

Select the picture mode.

If using the projector's control panel, press the Δ or ∇ button to select the picture mode, and press the \odot button to confirm the selection.

If using the remote control, tilt the \odot button vertically to select the picture mode, and press the \odot button to confirm the selection.



You can also make the setting from the line menu. (p.38)

Selecting the Image Aspect Ratio

This selects the ratio between the height and width of the projected images.

If the input signal includes aspect ratio information, the projector's automatic mode will detect this information and use it to automatically change the aspect ratio to the optimum ratio.

- Automatic mode can only be set when signals are being input to the VIDEO, S VIDEO, D4 or HDMI port.
When such signals are projected in automatic mode, the projector switches to the optimum aspect ratio depending on the signal as shown below.
 - For 4:3 input signals → **Normal**
 - For input signals recorded in squeeze mode → **Squeeze**
 - For letterbox input signals → **Zoom**
- * If the connected equipment is not EIAJ-compliant, the signals will be projected in Normal mode.

The default settings for each connection port are as follows.

- VIDEO, S VIDEO, D4 and HDMI ports → **Auto**
- INPUT A and INPUT B ports → **Normal**

1

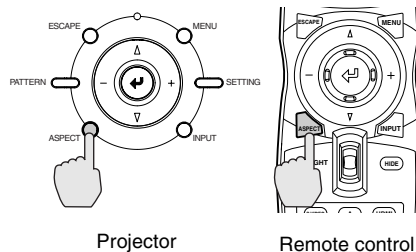

Press the [ASPECT] button on the projector's control panel or the button on the remote control.

The select (Resize) menu will be displayed.

2

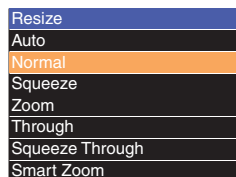

Select the aspect mode.

If using the projector's control panel, press the Δ or ∇ button to select the aspect Mode, and press the \odot button to confirm the selection.

If using the remote control, tilt the \odot button vertically to select the aspect Mode, and press the \odot button to confirm the selection.

Details of each aspect ratio are as follows.

Normal mode

4:3 image

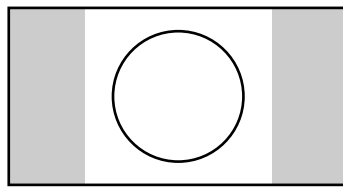
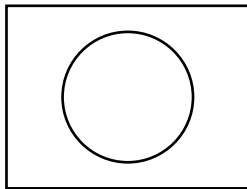

The aspect ratio of the images being input is maintained, and the images are projected into a 16:9 screen area. If projecting images in 4:3 mode such as normal TV broadcasts and computer images, black bands will be displayed at the left and right as shown in the illustration at left.

HDTV images

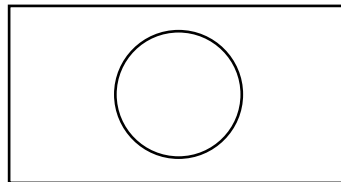
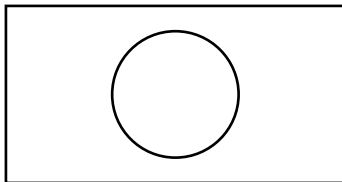

If projecting HDTV images, they will be projected in 16:9 format.

Squeeze mode

When projecting 4:3 TV images recorded in squeeze mode

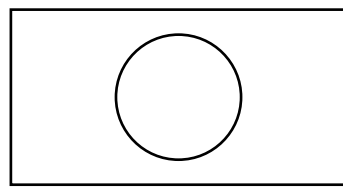
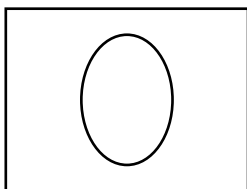

Viewed using the projector

This is used when projecting images that have been recorded in squeeze mode using a video camera or DVD recorder. When viewing images recorded in squeeze format on a 4:3 TV, the images will be compressed in the horizontal direction and elongated vertically. If squeeze mode is selected for the projector, the images can be projected in their original wide format (16:9).

4:3 image

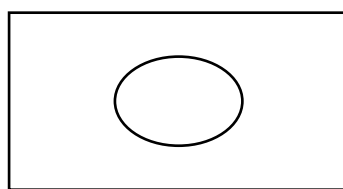
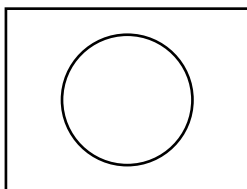

When the projector's squeeze mode is applied

When images output in 4:3 format are projected using the projector's squeeze mode, the images will be extended horizontally and the image will appear elongated.

Zoom mode

Letterbox images

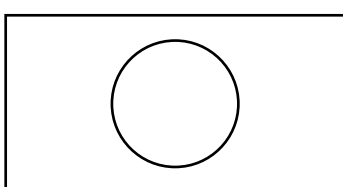
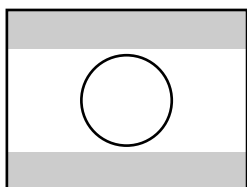

Resized to 16:9

Images in letterbox mode from equipment such as a DVD player will be cut at top and bottom by a fixed amount and resized to 16:9 format. If this causes captions to be truncated from images that have them, use the "Zoom Caption" menu command to adjust. (p.33)

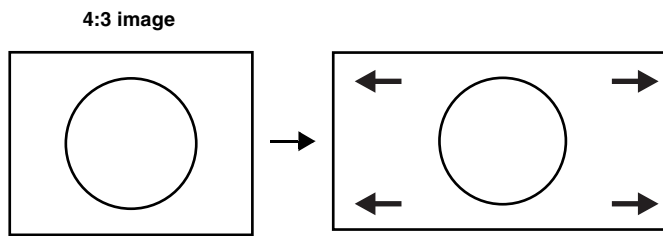
Smart Zoom mode

Images in 4:3 format such as normal TV broadcasts are extended horizontally, with less elongation in the middle and more elongation at the edges.

This is useful for when 4:3 images are projected onto a wide screen. Because there is almost no distortion due to enlargement in the middle of the images, the images appear close to what they would be at their original size. And because both ends of the images are enlarged, movement at the edges of the images appears faster and gives an impression of greater speed, making it ideal for viewing sporting events.

*If keystone correction has been carried out, Smart Zoom mode cannot be selected.

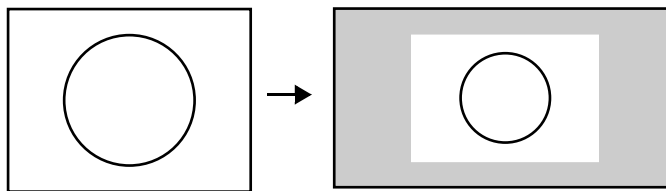
Through mode

If the input signal resolution is 1280 x 720 dots or less, the images are projected onto the screen with the input signal resolution unchanged. Because of this, the size of the displayed images will change depending on the input resolution.

The picture quality will be the clearest for portions of the image that have not been resized horizontally or vertically.

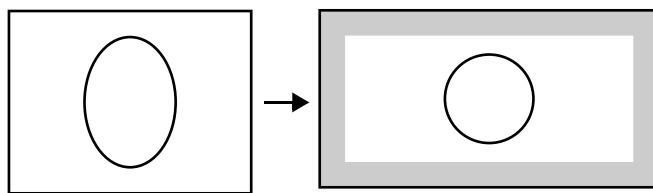
Squeeze Through mode

If the input signal resolution is 1280 x 720 dots or less, the input signal resolution is elongated horizontally and the images are projected at an aspect ratio of 16:9.

Because of this, the size of the displayed images will change depending on the input resolution.

The portions that are not vertically resized will appear with higher image quality.

Advanced Operations

This chapter describes functions for enhancing the projection of images, and how to use the menus.

Functions for Enhancing Projection	24
• Description of Functions	24
• White Level Adjustment	24
• Black Level Adjustment	24
• Input Level Adjustment	24
• Contrast Adjustment	24
• Absolute Color Temperature and Flesh Tone Adjustment	25
• RGB adjustment	25
• Saving and Retrieving Image Quality Settings (Memory Save)	26
• Settings that can be saved in memory	26
• Storing image quality settings	26
• Retrieving Saved Image Quality Settings	27
Using the Menu Functions	28
• List of Menus	28
• "Image" Menu	30
• Picture Quality	30
• Color Adjustment	31
• Picture Mode	31
• Memory Save	31
• Auto Setup	31
• Reset	31
• "Setup" Menu	32
• Signal	32
• Screen	33
• Operation	34
• User's Logo	35
• On-Screen Display	35
• Input Signal	36
• Language	36
• Reset	36
• "Info" Menu	36
• "Reset" Menu	36
• Lamp-Hours Reset	36
• Memory Reset	36
• All Reset	36
• Using the Menus	37
• Displaying and Operating Full Menus	37
• Displaying and Operating Line Menus	38

Functions for Enhancing Projection

This section explains how to use the functions for adjusting the picture quality to the optimum quality.

Description of Functions

White Level Adjustment

Adjusts the brightness of bright shades without changing the black level.

Use the "Image" - "Picture Quality" - "Input Adjustment" - "White Level/Black Level" - "White Level" menu item to change the setting. (p.30)

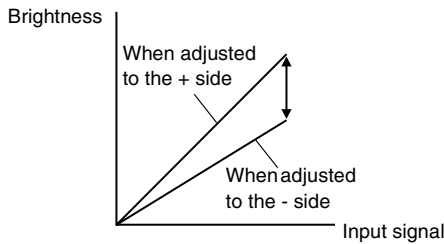

If adjusted to the + side, the luminosity of light scenes increases and contrast become clearer, but differences in light tones are reduced.

If adjusted to the - side, differences in light areas become more distinct, but contrast is reduced.

Black Level Adjustment

Adjusts the brightness of dark shades without changing the white level.

Use the "Image" - "Picture Quality" - "Input Adjustment" - "White Level/Black Level" - "Black Level" menu item to change the setting. (p.30)

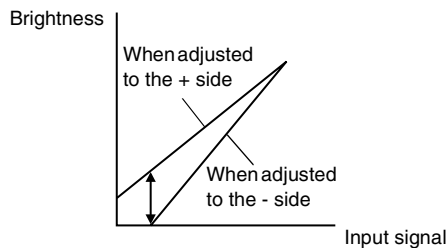

If adjusted to the + side, the luminosity of dark scenes increases and different tones become clearer, but contrast is reduced.

If adjusted to the - side, the brightness of dark shades is reduced and images with greater contrast are obtained, but differences in dark areas become less distinct.

Input Level Adjustment

Adjusts the overall brightness of the images.

When the setting is changed to the + side, the images appear brighter overall.

Use the "Image" - "Picture Quality" - "Input Adjustment" - "Input Level/Contrast" - "Input Level" menu item to change the setting. (p.30)

Contrast Adjustment

Adjusts the difference between bright and dark areas.

When the contrast is increased, sharper images are obtained.

Use the "Image" - "Picture Quality" - "Input Adjustment" - "Input Level/Contrast" - "Contrast" menu item to change the setting. (p.30)

Absolute Color Temperature and Flesh Tone Adjustment

The absolute color temperature adjusts the tint of the whole image.

Flesh tone adjustment adjusts the color of flesh tones to the desired color.

Use the "Image" - "Color Adjustment" - "Abs. Color Temp." and "Flesh Tone" menu items to change the settings. (p.31)

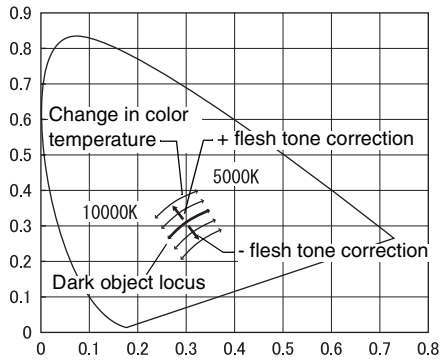

- **Abs. Color Temp.**

If you select a higher value, images appear bluish, and if you select a lower value, images appear reddish. The absolute color temperature can be set to one of 12 settings within the range of 5000K to 10000K.

- **Adjusting flesh tones**

The CB (color balance) Filter will be applied automatically so that flesh tones will appear in natural tints in accordance with the "Picture Mode" setting. If you would like to adjust the flesh tones to your own preference, use the "Flesh Tone" setting to adjust. If a large value is set, flesh tones appear greenish, and if a smaller value is set, flesh tones appear purplish.

RGB adjustment

The image brightness can be adjusted by adjusting the individual R (red), G (green) and B (blue) components of the dark areas (offset), bright areas (gain) and intermediate areas (gamma) respectively. Because such detailed adjustments are possible, images with greater depth can be obtained. (p.31)

Offset adjustment

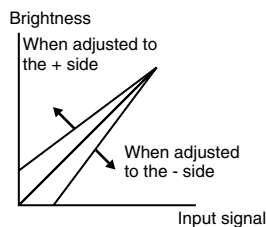

To make dark areas appear more clearly, adjust to the + side. If adjusted to the - side, the whole image will become sharper, but the contrast for dark areas will become poorer.

Gain adjustment

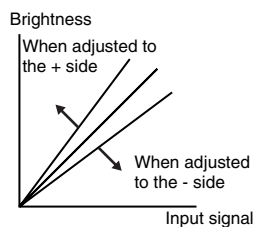

If you would like bright areas to appear more clearly, change the setting to the - side. If you change it to the + side, bright areas will become whiter, but the contrast will become poorer.

Gamma adjustment

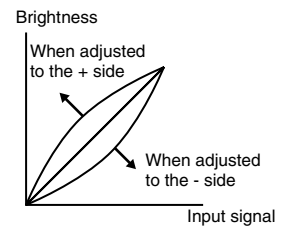

If the setting is changed to the - side, smoother images can be obtained. If the setting is changed to the + side, sharper images can be obtained.

Saving and Retrieving Image Quality Settings (Memory Save)

Once the "Picture Quality" and "Color Adjustment" menu commands have been used to adjust the projected images, the adjustment values can then be stored. In addition, the saved data can be retrieved easily, so that you can enjoy viewing images with the adjusted settings at any time.

Settings that can be saved in memory

- menus (p.28)

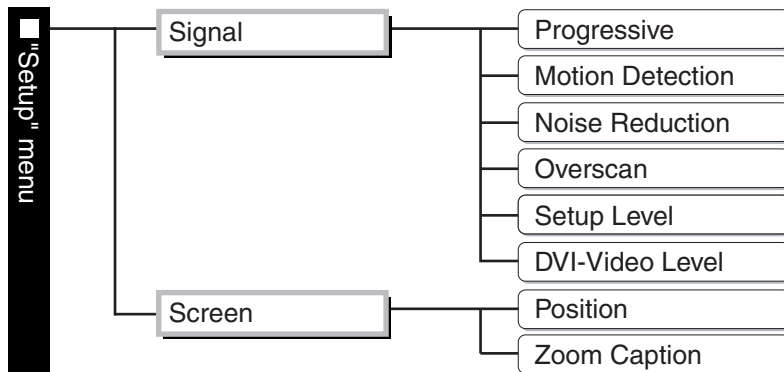
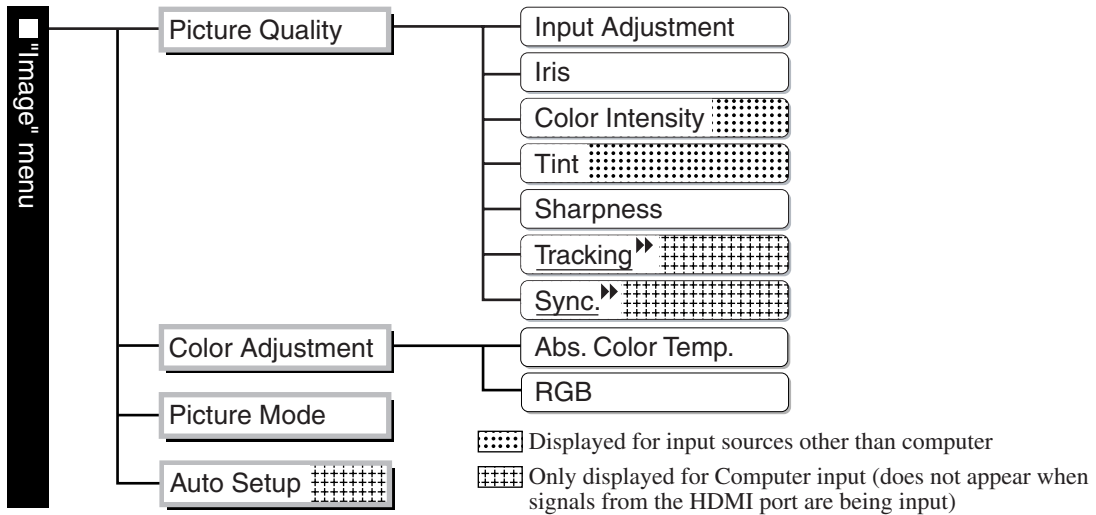

- Aspect (p.19)

Storing image quality settings

1

Projector

Remote control

Press the [MENU] button on the projector's control panel or the button on the remote control.

The menu will be displayed, with the adjustment values appearing as are currently set.

2

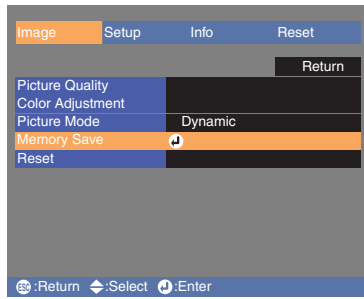

Select "Memory Save" from the sub-menu of the "Image" menu, and then press the button on the projector's control panel or the button on the remote control.

3

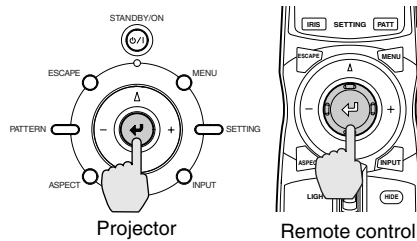

Select the memory number (1 - 6) to use for saving the settings, and then press the button on the projector's control panel or the button on the remote control.

The icon for the memory number selected will change from to .

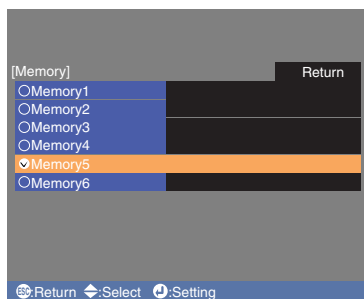

If you select a memory number that already contains stored settings, the previous settings will be cleared and the current settings will be stored in their place.

Retrieving Saved Image Quality Settings

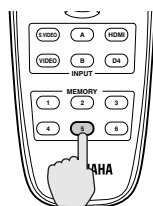

Remote control

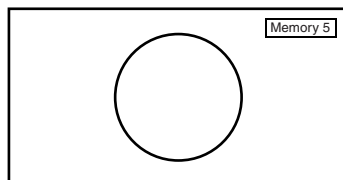

Press one of the remote control memory buttons [1] to [6] corresponding to the image quality settings to be retrieved.

The selected memory number will be displayed at the top-right of the screen, and the setting values will be applied to the images that are being projected.

• If you press one of the remote control memory buttons [1] to [6] that has no stored memory settings, the images being projected will not change.

• Memory settings that have been applied to images will be retained even when the projector's power is turned off. The same memory adjustment settings will be applied to images that are projected the next time the projector's power is turned on.

• The aspect setting retrieved from memory may not be applied to the images if they are 16:9 images or if the input signal images have a particular resolution.

Using the Menu Functions

The menus can be used to make adjustments and settings for items such as the screen, image quality and input signal. The following two types of menu are available.

- Full menu

This lets you check all menu items while making settings.

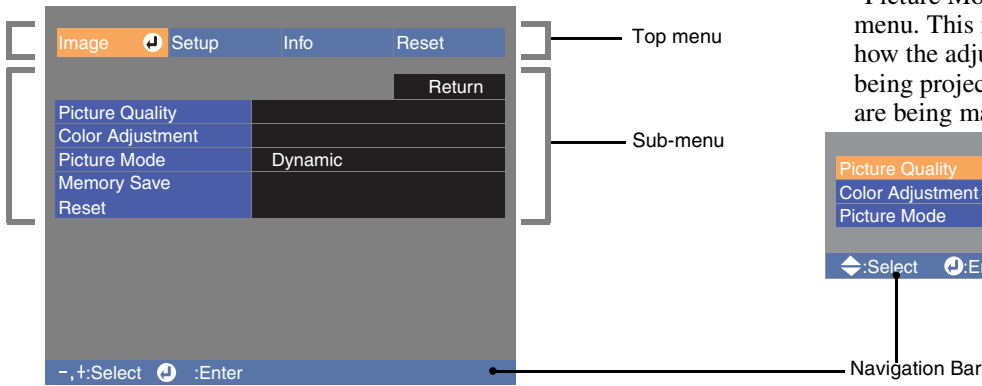

- Line menu

This lets you adjust the "Picture Quality", "Color Adjustment" and "Picture Mode" items in the "Image" menu. This menu is useful for checking how the adjustments affect the images being projected while the adjustments are being made.

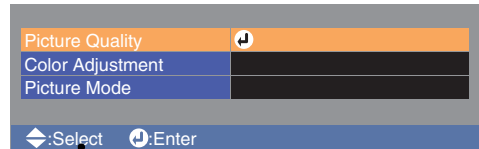

Refer to "Using the menus" (p.37) for details on using the menus.



The navigation bar can be turned on and off and the color pattern and display position for menus can be changed.

"Setup" - "On-Screen Display" - "Menu Position", "Navigation Bar", "Menu Color"

List of Menu

If no image signals are being input, settings other than "Iris" in the "Picture Quality" sub-menu of the "Image" menu cannot be adjusted. The commands displayed as part of the "Image" menu and "Info" menu will vary depending on the image signals.

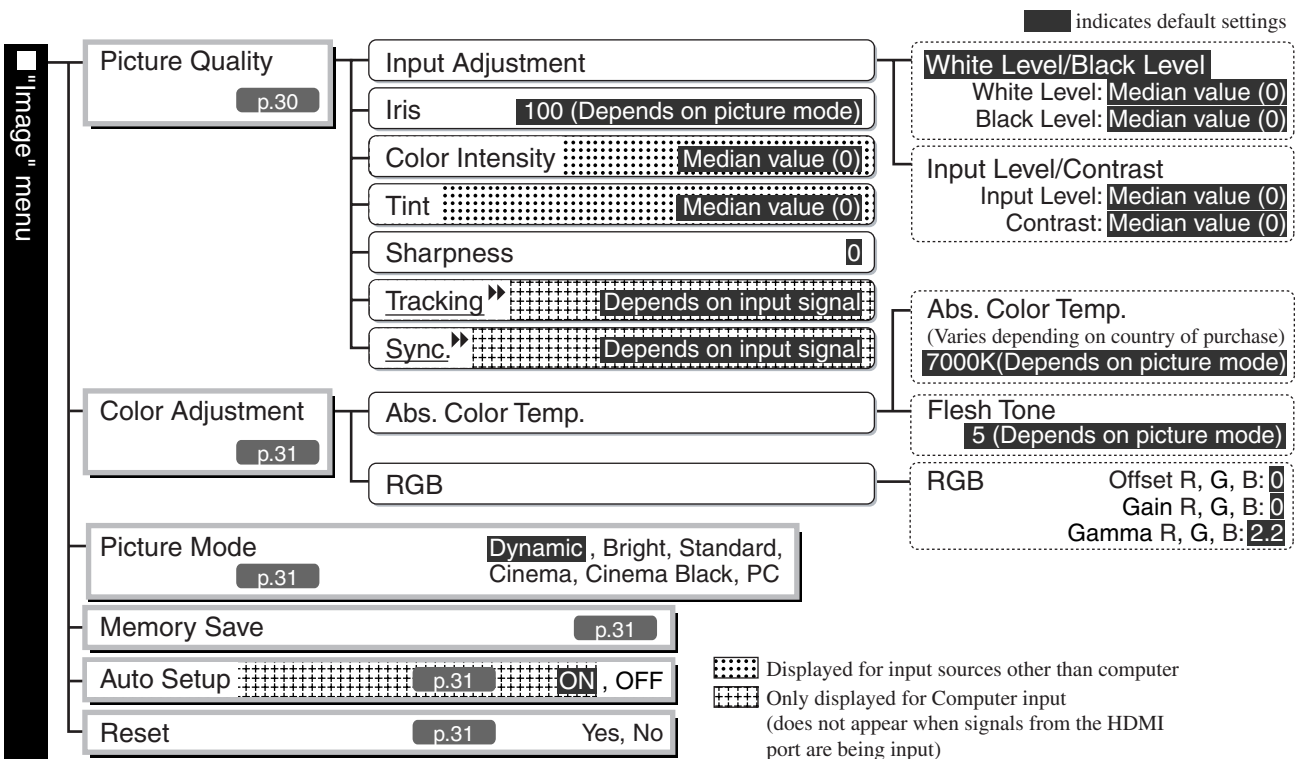



■ indicates default settings

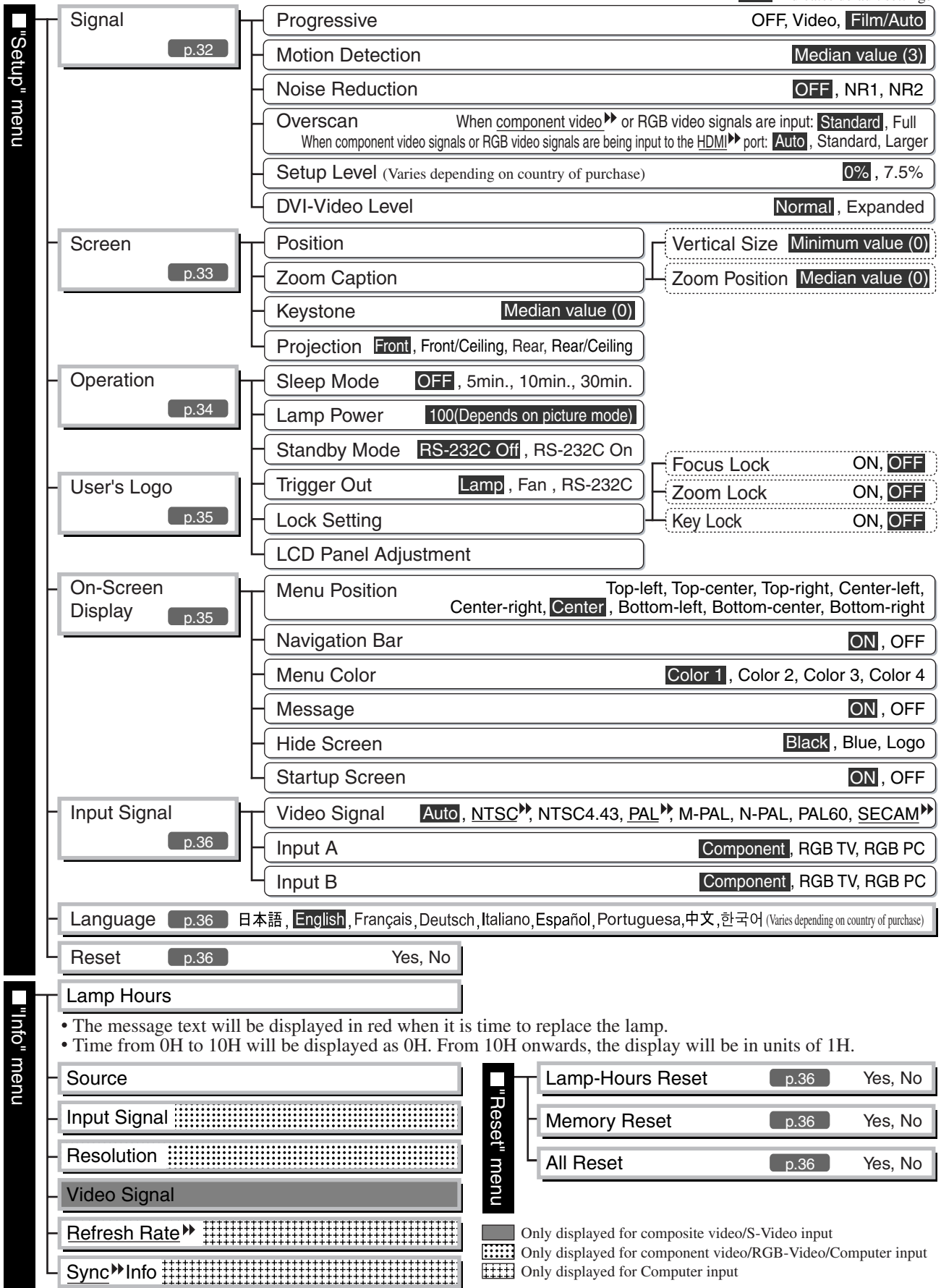

■ Only displayed for composite video/S-Video input
 ■ Only displayed for component video/RGB-Video/Computer input
 ■ Only displayed for Computer input

The "Info" menu is only used to display the projector status.

"Image" Menu

The image quality adjustment items are determined by the input port (image signal) that is selected.

- INPUT A, B (Component),
INPUT A, B (RGB TV),
HDMI, VIDEO, S-VIDEO
- When computer signals are being input
INPUT A, B (RGB PC)

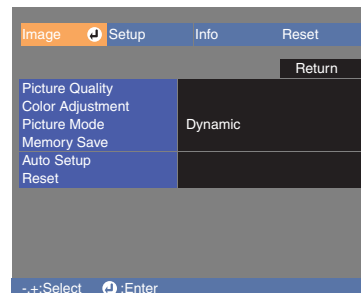
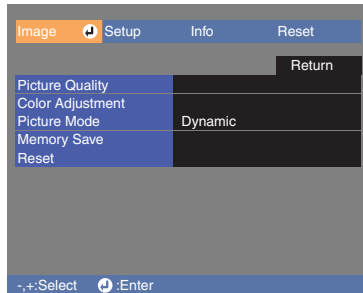

Picture Quality

Main menu	Function	Default setting
Input Adjustment * ¹	<p>These settings can be adjusted if the output level of the connected equipment is weak and the images appear dark. The two settings cannot be made simultaneously. You can only select one of them to be adjusted.</p> <ul style="list-style-type: none"> • White Level/Black Level : These adjust the dark and light areas of images <ul style="list-style-type: none"> White Level : Adjusts the brightness of bright shades without changing the black level. When the setting is changed to the - side, bright areas become clearer. Black Level : Adjusts the brightness of dark shades without changing the white level. When the setting is changed to the + side, dark areas become clearer. • Input Level/Contrast : Adjusts the overall brightness of the images. <ul style="list-style-type: none"> Input Level : Adjusts the overall brightness of the images. When the setting is changed to the + side, the images appear brighter overall. Contrast : Adjusts the difference between bright and dark areas. When the contrast is increased, sharper images are obtained. 	<p>White Level/ Black Level</p> <hr/> <p>White Level: Median value (0) Black Level: Median value (0)</p> <hr/> <p>Input Level: Median value (0) Contrast: Median value (0)</p>
Iris* ²	<p>The brightness of the images can be adjusted. When projecting in dark rooms or onto small screens and the images appear too bright, decrease the setting.</p>	100 (Depends on picture mode)
Color Intensity * ¹	<p>(Setting is only possible when signals other than computer signals are being input.) This adjusts the color intensity for the images.</p>	Median value (0)
Tint * ¹	<p>(Setting is only possible when signals other than computer signals [S-Video or NTSC signals] are being input.) This adjusts the image tint.</p>	Median value (0)
Sharpness * ¹	<p>This adjusts the image sharpness.</p>	0
Tracking * ¹	<p>(Setting is only possible when computer signals are being input to the INPUT A or INPUT B port.) This adjusts the images if vertical stripes appear in the images.</p>	Depends on input signal
Sync. * ¹	<p>(Setting is only possible when computer signals are being input to the INPUT A or INPUT B port.) This adjusts the images if flickering, fuzziness or interference appear in the images. • Flickering and fuzziness may also appear in images when the brightness, contrast, sharpness and keystone correction settings are adjusted. • Clearer adjustments can be obtained if you adjust the tracking first and then adjust the sync.</p>	Depends on input signal

*1 The setting values are stored separately for each image source and signal type.

*2 The settings are stored separately for each image source and the picture mode setting.

Color Adjustment

If the picture mode is set to "PC", "Color Adjustment" cannot be selected.

Main menu	Function	Default setting
Abs. Color Temp. * ²	<ul style="list-style-type: none"> •Abs. Color Temp. : This adjusts the overall tints of the images in accordance with the images being projected. (p.25) 	7000K (Varies depending on country of purchase) (Depends on picture mode)
	<ul style="list-style-type: none"> •Flesh Tone : This adjusts the flesh tones of people who appear in the images. (p.25) 	5 (Depends on picture mode)
RGB * ¹	This lets you adjust the offset, gain and gamma for each of the R/G/B color components. (p.25)	Offset R/G/B: 0 Gain R/G/B: 0 Gamma R/G/B: 2.2

*1 The setting values are stored separately for each image source and signal type.

*2 The settings are stored separately for each image source and the picture mode setting.

Picture Mode *¹

The picture mode can be selected from six different settings in accordance with the images being projected. (Default setting: Dynamic) (p.18)

*1 The setting values are stored separately for each image source and signal type.

Memory Save

This can be used to save the current "Image" and "Setup" configuration menu settings and the aspect. (p.26)

Auto Setup *¹

(Setting is only possible when computer signals are being input.)

This sets automatic adjustment to on or off in order to set whether the projector automatically adjusts images to their optimum condition when the input signal is changed. (Default setting: ON)

*1 The setting values are stored separately for each image source and signal type.

Reset

Returns all adjustment values in the "Image" menu (other than the values stored using the "Memory Save" command) to their default values. "Memory Save" is reset using the "Memory Reset" command. (p.36)

"Setup" Menu

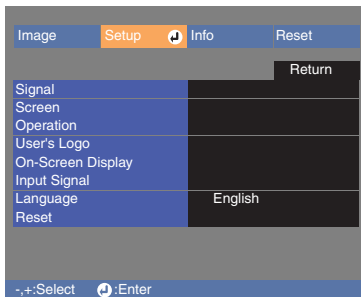

Signal

Main menu	Function	Default setting
Progressive * ¹	<p>(Setting is only possible when <u>composite video</u>, <u>S-Video</u>, <u>component video</u> or 480i and 576i RGB video signals are being input.)</p> <ul style="list-style-type: none"> • OFF : Conversion of <u>interlaced</u> (i) signals to progressive (p) signals is carried out for each field in the screen. This is ideal for using when viewing images with a large amount of movement. • Video : IP conversion is carried out. The film judgment function is turned off. This is ideal for general video images. The <u>DCDi</u> function operates. • Film/Auto : Automatically judges the input source if it is a film source or not. When it is judged as a film, the image equivalent with its original source will be projected. The <u>DCDi</u> function operates. 	Film/Auto
Motion Detection	<p>(Setting is only possible when composite video, S-Video, component video and 480i and 576i RGB video signals are being input.)</p> <p>This adjusts the IP conversion settings depending on whether the images contain large amounts of movement or they are still (or slow) images.</p> <p>If a smaller value is selected, flickering is reduced and images become sharper and more detailed, so this is ideal for viewing still images. If a larger value is selected, the movement becomes smoother with less aliasing and so this is ideal for viewing moving images.</p>	Median value (3)
Noise Reduction* ¹	<p>(Setting is only possible when composite video signals or S-Video signals are being input.)</p> <p>This suppresses interference in images and makes the images appear softer. If viewing images with little or no interferences, such as images from DVDs, it is recommended that you change this setting to "OFF".</p>	OFF
Overscan* ¹	<p>(Setting is not possible when composite video, S-Video or analogue-RGB signals are being input.)</p> <p>This changes the display area (the part of projected images).</p> <ul style="list-style-type: none"> • When component video or RGB-video signals are being input <ul style="list-style-type: none"> Standard (92% display) : Input signals are projected at the normal image size. TV images are displayed at 92% size. Full (100% display) : The areas at the top, bottom and sides of images that cannot normally be seen are inserted and projected. Interference may occur at the top or bottom of the images depending on the image signal. • When the HDMI port is connected <ul style="list-style-type: none"> Auto : Signals are automatically projected at 100% or 92% size depending on the input signals. (Not displayed when the equipment's DVI port is connected to the projector's HDMI port.) Standard (100% display): Input signals are projected at the full image size. Larger (92% display) : The edges of the images are truncated when projected. Select this option if there is interference at the top or bottom of the images. 	<p>Standard</p> <hr/> <p>Auto</p>

Main menu	Function	Default setting
Setup Level *1	(Setting is only possible when composite video or S-Video signals in NTSC format are being input or component video has been set. Setting is not possible when signals are being input from the HDMI port.) If using products designed for destinations such as the United States or South Korea that have different black level (setup level) settings, use this function to obtain correct images. Check the specifications of the connected equipment when changing this setting.	0% (Varies depending on country of purchase)
DVI-Video Level *1	(Setting is only possible when RGB video or computer signals are being input from the HDMI port.) If the projector's HDMI port is connected to the DVI port of a DVD player or similar equipment using an HDMI/DVI cable, set the video level for the projector to match the video level that has been set at the DVD player. The setting at the DVD player can be either Normal or Expand.	Normal



*1 The setting values are stored separately for each image source and signal type.

Screen

Main menu	Function	Default setting
Position *1	(Setting is not possible when signals are being input from the HDMI port.) If using the projector's control panel, press the Δ , ∇ , $-$ and $+$ buttons to move the image display position. If using the remote control, tilt the $\text{\textcircled{+}}$ button horizontally and vertically.	
Zoom Caption *1	If aspect is set to "Zoom" when viewing images with subtitles, change the setting as follows so that the subtitles are displayed. The vertical size and the display position can both be adjusted together. <ul style="list-style-type: none"> • Vertical Size The vertical size of the image is reduced so that the subtitles are displayed. • Zoom Position The whole of the image is moved up so that the subtitles are displayed. 	Minimum value (0) Median value (0)
Keystone	(If the aspect mode is set to "Smart Zoom", keystone correction cannot be set.) This is used to correct keystone distortion in images. The same correction can be carried out using the projector's control panel. (p.13)	Median value (0)
Projection	This should be set in accordance with the method used to set up the projector. <ul style="list-style-type: none"> • Front : Select when the projector is set up in front of the screen. • Front/Ceiling : Select when the projector is set up in front of the screen and suspended from a ceiling. • Rear : Select when the projector is set up behind the screen. • Rear/Ceiling : Select when the projector is set up behind the screen and suspended from a ceiling. 	Front

*1 The setting values are stored separately for each image source and signal type.

Operation

Main menu	Function	Default setting
Sleep Mode	The projector is equipped with a power-saving function that causes the power to turn off automatically and the projector to switch to standby if no signal is input to the projector for a continuous length of time. The length of time before the power-saving function operates can be selected from four available settings. If "OFF" is selected, the power-saving function will not operate. If the projector is in standby mode, press the [STANDBY/ON] button on the projector's control panel or the  button on the remote control to start projection.	OFF
Lamp Power	The purpose of this command is to extend the lamp's useful life. It lets you set the power supplied to the lamp to one of 6 levels to adjust the lamp brightness. If the adjustment value is set to "75", the power supplied to the lamp is reduced by about 25%.	100 (Depends on picture mode)
Standby Mode	This sets the standby conditions that are activated when the power is turned off. If set to "RS-232C Off", the power output in standby mode becomes 0.4 W. If set to "RS-232C On", the power output in standby mode becomes 3.0 W. Set to "RS-232C On" if you would like the projector to be able to receive communication commands when the power is turned off. When this setting is changed, turn off the power, and when the cool-down period has finished, turn the power back on again. The new setting will be applied after the power turns back on.	RS-232C Off
Trigger Out	This sets whether or not a 12 V signal is output from the TRIGGER OUT port to external equipment in synchronization with the operation of the lamp and fan. When set to "RS-232C", it turns trigger output on and off by means of control signals from the RS-232C port. When this setting is changed, turn off the power, and when the cool-down period has finished, turn the power back on again. The new setting will be applied after the power turns back on.	Lamp
Lock Setting	This lets you turn the settings for the various lock functions on and off. When a lock function is on, a  icon appears on the screen when a button is pressed. <ul style="list-style-type: none"> • Focus Lock : Focus adjustment is disabled. • Zoom Lock : Zoom adjustment is disabled. • Key Lock : If this is set to "ON", you can't operate the projector's control panel buttons. If you change the setting, the new setting will take effect after exiting the configuration menu. (To cancel) Use the remote control to return the setting to "OFF". 	OFF OFF OFF
LCD Panel Adjustment	If vertical interference appears in the projected images, use this setting to remove it. <ul style="list-style-type: none"> • Vertical Stripe Adjustment R: While checking the red tone adjustment screen, adjust until the stripes are no longer noticeable. • Vertical Stripe Adjustment G: While checking the green tone adjustment screen, adjust until the stripes are no longer noticeable. • Vertical Stripe Adjustment B: While checking the blue tone adjustment screen, adjust until the stripes are no longer noticeable. 	

User's Logo

You can record your favorite image as a user's logo.

A user's logo can be stored for projecting when the projector starts up and when projecting the hide screen. When a user's logo is recorded, the previous user's logo will be erased. Follow the instructions on the screen to record a user's logo. (Default setting:  YAMAHA)

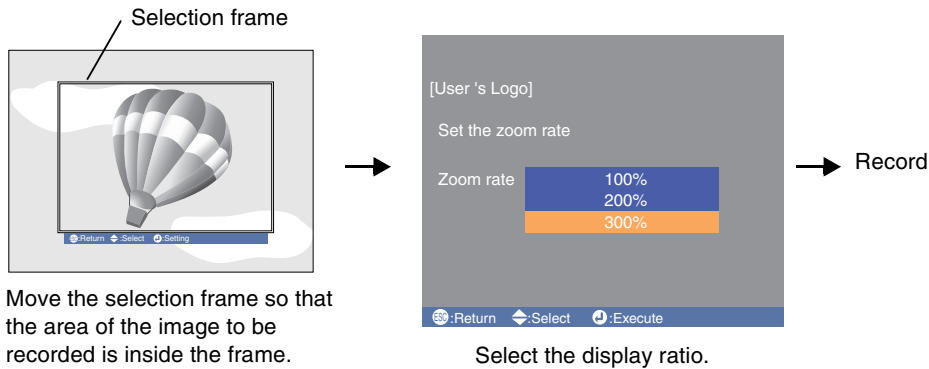



Move the selection frame so that the area of the image to be recorded is inside the frame.

Select the display ratio.

- The image will be displayed in dot format while the selection frame is displayed, therefore the display size may change.
- The size of the recorded image is 480 × 360 dots.
- Once a user's logo has been recorded, you cannot return the logo to the default setting.
- To use the stored user's logo, set "Hide Screen" to "Logo".

On-Screen Display

Main menu	Function	Default setting
Menu Position	If using the projector's control panel, press the Δ , ∇ , $-$ and $+$ buttons to set the menu display position. If using the remote control, tilt the  button horizontally and vertically.	Center
Navigation Bar	This sets the menu navigation bar to be displayed (ON) or not displayed (OFF).	ON
Menu Color	This selects the color of the main menu for full menus and the navigation bar to one of 4 choices.	Color 1
Message	This sets whether the following message is displayed (ON) or not displayed (OFF). <ul style="list-style-type: none"> • Command name display when image signal, picture mode, aspect, test pattern or memory settings are retrieved. • Messages such as when no image signals are being input, when an incompatible signal is input, and when the internal temperature rises 	ON
Hide Screen	This sets the screen status when the  button on the remote control is pressed. The screen status can be selected from "Black", "Blue" or "Logo".	Black
Startup screen	This sets whether a startup screen (an image that is projected when projection starts) is to be displayed (ON) or not displayed (OFF). When this setting is changed, turn off the power, and when the <u>cool-down</u>  period has finished, turn the power back on again. The new setting will be applied after the power turns back on.	ON

Input Signal

Main menu	Function	Default setting
Video Signal	Sets the signal format in accordance with the video equipment that is connected to the VIDEO or S VIDEO port. If set to "Auto", the video signal format is set automatically. If there is a lot of interference in the image, or if a problem such as no image being projected occurs even though "Auto" has been selected, select the correct signal format manually.	Auto
Input A Input B	Sets the signal format in accordance with the video equipment that is connected to the INPUT A or INPUT B port or the signal being output from a computer.	Component

Language

This sets the display language for messages and menus. (Default setting:English
(Varies depending on country of purchase))

Reset

This returns all adjustment values in the "Setup" menu (other than the "User's Logo", "Input Signal" and "Language" command settings) to their default values.

"Info" Menu

The "Info" menu shows information about the operating status of the projector such as lamp usage time, image source, input signal, input resolution, video signal format, refresh rate and sync information.

"Reset" Menu

Lamp-Hours Reset

This initialises the lamp operating time. When this command is selected, the cumulative operating time for the lamp is cleared and returned to the default setting.

Memory Reset

This resets (clears) all settings that have been stored using the "Memory Save" command.

All Reset

This resets all menu command settings. However, the "Memory Save", "User's Logo", "Input Signal", "Lamp Hours" and "Language" settings are not reset.

Using the Menu

Displaying and Operating Full Menus

Menus can be operated using the projector's control panel and also by using the remote control.

1

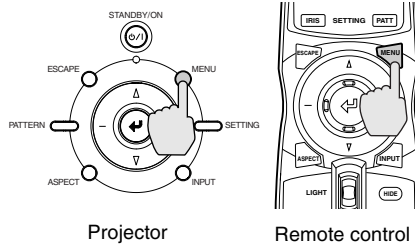

Display the menu screen.

Press the [MENU] button on the projector's control panel or the  button on the remote control.

The menu appears.
Full menus consist of a main menu and sub-menus.

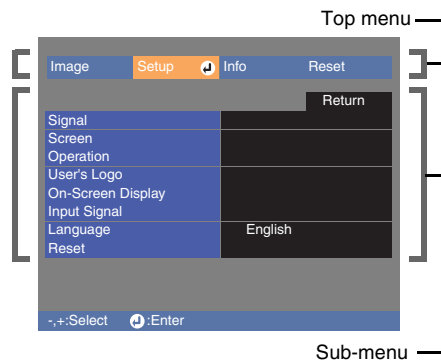

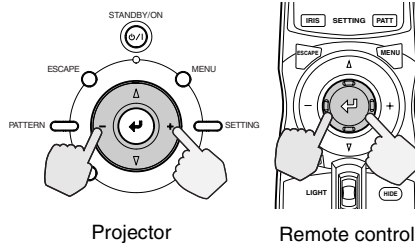

2



Select the items to be changed in the main menu.

If using the projector's control panel, press the – or + button to select a command, and then press the  button.

If using the remote control, tilt the  button to the left or right to select a command, and then press the  button.

3

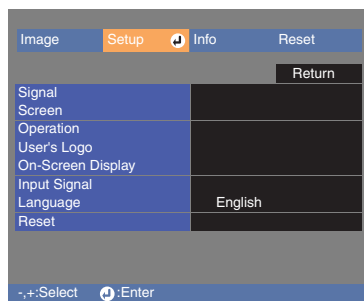



Select a setting item in the sub-menu.

If using the projector's control panel, press the Δ or ∇ button to select a command.

If using the remote control, tilt the  button up or down to select a command.



If a setting is executed or a sub-menu item continues to another level, " " appears after the item name. In such cases, press the  button on the projector's control panel or the  button on the remote control to select the setting displayed in the menu.

4

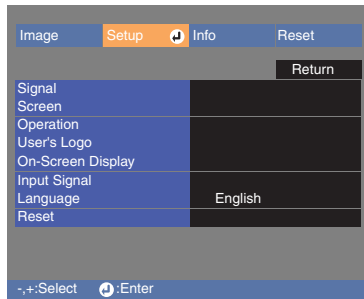

Change the setting.

If using the projector's control panel, press the **-** or **+** button to make the setting.
 If using the remote control, tilt the **←** button to the left or right.
 If a selection menu is displayed, select an item, and then press the **→** button on the projector's control panel or the **→** button on the remote control to confirm the setting.



To return to a previous level, press the [ESCAPE] button on the projector's control panel or the **← button on the remote control, or select "Return".**

5

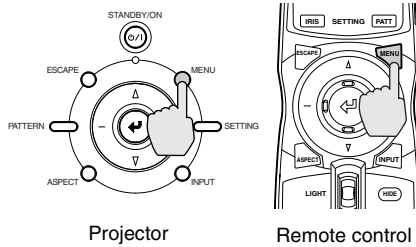

Exit the menu display.

Press the **[MENU]** button on the projector's control panel or the **←** button on the remote control.

Displaying and Operating Line Menus

1

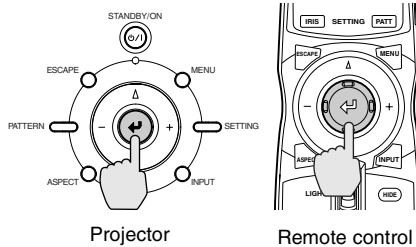

Press the **+ button on the projector's control panel or the **+** button on the remote control while the full menu is not being displayed.**

The line menu appears.

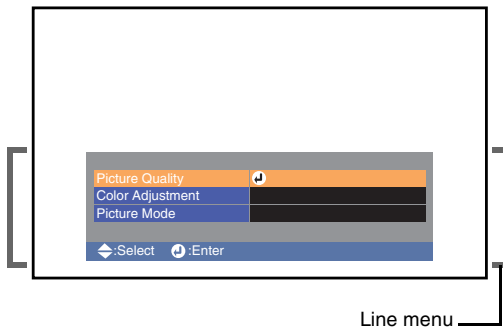

2

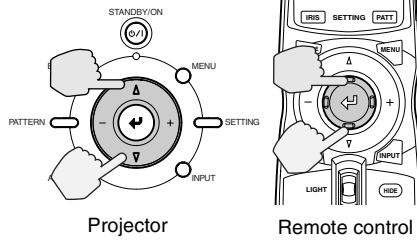

Projector

Remote control

Select an item to be set.

If using the projector's control panel, press the Δ or ∇ button to select a command.

If using the remote control, tilt the MENU button up or down to select a command.

The line menu item changes when a button is pressed.



If a setting is executed or a sub-menu item continues to another level, " MENU " appears after the item name. In such cases, press the MENU button on the projector's control panel or the MENU button on the remote control to select the setting displayed in the menu.

3

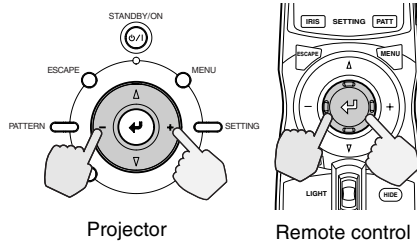

Projector

Remote control

Change the setting.

If using the projector's control panel, press the $-$ or $+$ button to make the setting.

If using the remote control, tilt the SETTING button to the left or right.



To return to a previous level, press the [ESCAPE] button on the projector's control panel or the ESCAPE button on the remote control, or select "Return".

4

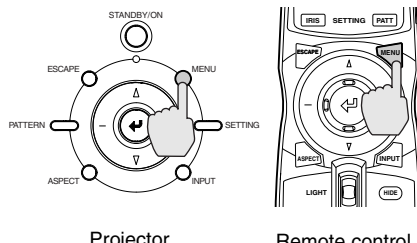

Projector

Remote control

Exit the menu display.

Press the [MENU] button on the projector's control panel or the MENU button on the remote control.

Troubleshooting

This chapter describes troubleshooting procedures for the projector.

When Having Some Trouble	42
When the Indicators Provide No Help	44
• Problems relating to images	44
• Problems when projection starts	48
• Problems with the remote control	48

When Having Some Trouble





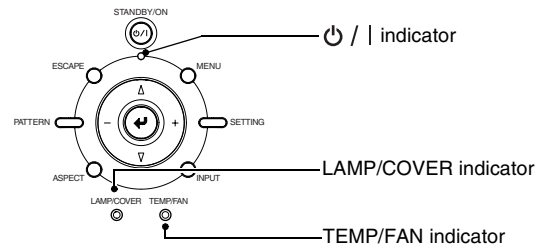















The projector is provided with the following three indicators which notify you of the operating status of the projector. The following tables show what the indicators mean and how to remedy the problems that they indicate.





*If the  indicator does not light when the power is turned on, the power cord may not be connected correctly or the power may not be supplied.



The following tables show what the indicators mean and how to remedy problems that they indicate.

● : lit ✨ : flashing ○ : off

Indicator status	Projector status	Problem and remedy	Reference page
Red Red Red  /  	Internal problem	Stop using the projector, disconnect the power cord from the electrical outlet, and contact your dealer.	
Red Red  /  	Fan problem/Sensor problem	Stop using the projector, disconnect the power cord from the electrical outlet, and contact your dealer.	
Red Red  /  	Lamp problem/ Lamp cover is open error	Check if the lamp is broken or if the lamp cover is not securely installed. If the lamp is not broken, reinstall it and then turn the power back on. If the indicators still show a problem, stop using the projector, turn off the main power switch, disconnect the power cord from the electrical outlet, and contact your dealer. If the lamp is broken, contact your dealer to request the lamp to be replaced.	p.53
Red Red  /  	Lamp operating error	Check if the lamp is broken or if the lamp cover is not securely installed. If the lamp is not broken, reinstall it and then turn the power back on. If the indicators still show a problem, stop using the projector, turn off the main power switch, disconnect the power cord from the electrical outlet, and contact your dealer. If the lamp is broken, contact your dealer to request the lamp to be replaced.	p.53
Red Red  /  	High temperature inside projector (overheating)	The lamp will turn off automatically and projection will stop. Wait for about 5 minutes without operating the projector. <ul style="list-style-type: none"> • If the projector is set up near a wall, leave a space of at least 20 cm between the wall and the projector. • If the air filter is blocked, it should be cleaned. If the problem is not solved when the power is turned back on, stop using the projector, turn off the main power switch, disconnect the power cord from the electrical outlet, and contact your dealer.	p.51 “Setup Guide”
Orange  	High-speed cooling in progress	(No abnormality) Projection can continue, but if the temperature rises too high again, projection will stop automatically. Carry out the same steps as for "High temperature inside projector". The appearance of the  / indicator at this time will vary depending on the status of the projector.	p.51 “Setup Guide”
Orange  	Lamp will soon need to be replaced.	(No abnormality) It is time to replace the lamp. Replace the lamp with a spare one as soon as possible. If you continue to use the old lamp, there is the danger that it may break. The appearance of the  / indicator at this time will vary depending on the status of the projector.	p.53

Indicator status	Projector status	Problem and remedy	Reference page
Orange 	Standby condition	(No abnormality) If you press the [STANDBY/ON] button on the projector's control panel or the  button on the remote control, projection will start after the warm-up is complete.	p.6
Green 	Warm-up in progress	(No abnormality) The warm-up period is approximately 30 seconds. Wait for short while. The indicator will stop flashing and light green. The power cannot be turned off while warm-up is in progress.	p.7
Green 	Projection in progress	(No abnormality) Normal operation is in progress.	p.7
Red/Orange 	Cool-down in progress	(No abnormality) The cool-down period is approximately 30 seconds. When cool-down is complete, the projector will switch to standby mode. The remote control and the projector's control panel cannot be used while cool-down is in progress.	p.9



- If there is a problem with the projected images even though the indicators do not show any abnormality, refer to "When the Indicators Provide No Help" on the following page.
- If an indicator is showing a status which does not appear in the previous tables, contact your dealer.

When the Indicators Provide No Help

If any of the following problems occur and the indicators do not offer a solution, refer to the pages given for each problem.



Probable relating to images	
<ul style="list-style-type: none"> ● No images appear Projection does not start, the projection area is completely black, the projection area is completely blue, etc. 	See below
<ul style="list-style-type: none"> ● The message "Not Supported." is displayed 	(p.45)
<ul style="list-style-type: none"> ● The message "No Signal." is displayed 	(p.45)
<ul style="list-style-type: none"> ● Images are fuzzy or out of focus 	(p.45)
<ul style="list-style-type: none"> ● Interference or distortion appear in images Problems such as interference, distortion or black & white checked patterns appear. 	(p.46)
<ul style="list-style-type: none"> ● Image is truncated (large) or small Only part of the image is displayed. 	(p.46)
<ul style="list-style-type: none"> ● Image colors are not right 	(p.47)
<p>The whole image appears purplish or greenish, images are black & white, colors appear dull, etc. (Computer monitors and LCD screens have different color reproduction performance, so that the colors projected by the projector and the colors appearing on the monitor may not necessarily match, but this is not a sign of a problem.)</p>	
<ul style="list-style-type: none"> ● Images appear dark 	(p.47)
<ul style="list-style-type: none"> ● Projection stops automatically 	(p.47)
<ul style="list-style-type: none"> ● Vertical lines appear in the projected images 	(p.47)

Problems when projection starts	
<ul style="list-style-type: none"> ● Power does not turn on 	(p.48)

Probable with the remote control	
<ul style="list-style-type: none"> ● The remote control does not work 	(p.48)

Problems relating to images

● No images appear

Have you pressed the [Power] button?	Press the  button on the remote control, or press the [STANDBY/ON] button on the projector's control panel.
Was the  / indicator lit orange before the power was turned on?	Disconnect the power cord and then reconnect it. (p.6) Check the circuit breaker to see if power is being supplied.
Is the hide screen activated?	Press the  button on the remote control to cancel the hide screen.
Is a video signal being input?	Check that the power supply for the connected equipment is turned on. If the "Message" menu command is set to "ON", a message regarding the image signal will be displayed. "Setup" - "On-Screen Display" - "Message" (p.35)
Are the image signal format settings correct?	Set the "Video Signal" command to match the equipment's signal format. "Setup" - "Input Signal" - "Video Signal" (p.36)
Is a menu setting incorrect?	Try resetting all of the current settings. (p.36)
Were the projector and the computer connected while their power was turned on? Only when projecting computer images	If the connection is made while the power is already turned on, the function (Fn) key that switches the computer's video signal to external output may not work. Turn off the power for the projector and the computer and then back on again.
Is the computer display output set to only the computer's accessory screen? Only when projecting computer images	The image signals need to be output externally. Change the output setting to an external destination only or to an external destination as well as the computer's own monitor. Computer documentation, under a title such as "External output" or "Connecting an external monitor"



● The message "Not Supported." is displayed

<p>Are the image signal format settings correct?</p>	<p>When a <u>composite video</u> or <u>S-Video</u> signal is being input. If images cannot be projected even when the "Video Signal" menu command is set to "Auto", change the setting to the signal format for the connected equipment. "Setup" - "Input Signal" - "Video Signal" (p.36)</p> <p>If connected to the INPUT A or INPUT B port Check that the connectors of the connection cable are inserted into the correct ports. (<i>Setup Guide</i>)</p>
<p>Does the mode match the frequency and resolution of the image signals?</p> <p>Only when projecting computer images</p>	<p>Use the "Resolution" menu command to check the image signals being input, and check that the resolution appears in "List of Supported Signal Resolutions". "Info" - "Resolution" (p.29) "List of Supported Signal Resolutions" (p.59)</p>

● The message "No Signal." is displayed

<p>Are the cables connected correctly?</p>	<p>Check that all of the cables required for projection are securely connected. (<i>Setup Guide</i>)</p>
<p>Has the correct video input port been selected?</p>	<p>Use the (D4), (A), (B), (HDMI), (SVIDEO) or (VIDEO) button on the remote control or the [INPUT] button on the projector's control panel to select the image source. (p.7)</p>
<p>Is the power for the connected equipment turned on?</p>	<p>Turn the power on for the devices.</p>
<p>Are the image signals being output to the projector?</p> <p>Only when projecting images from a laptop computer or computer with a built-in LCD screen</p>	<p>If the image signals are only being output to the computer's LCD monitor or to the accessory monitor, you need to change the output. For some computer models, when the image signals are output externally, they no longer appear on the LCD monitor or accessory monitor. Computer documentation, under a title such as "External output" or "Connecting an external monitor"</p> <p>If the connection is made while the power is already turned on, the function [Fn] key that switches the computer's video signal to external output may not work. Turn the power for the projector and the computer off and then back on again. (p.8)</p>

● Images are fuzzy or out of focus

<p>Has the focus been adjusted correctly?</p>	<p>Adjust the focus. (p.16)</p>
<p>Is the lens cap still attached?</p>	<p>Remove the lens cap.</p>
<p>Is the projector at the optimum distance?</p>	<p>The recommended distance from the projector to the screen is within 87–1365 cm (2.9–44.8 ft.) for a screen size of 16:9, and 108–1672 cm (3.6–54.9 ft.) for a screen size of 4:3. Set up the projector so that the projection distance is within this range. (<i>Setup Guide</i>)</p>
<p>Is the keystone adjustment value too large?</p>	<p>Decrease the projection angle to reduce the amount of keystone correction. (p.13)</p>
<p>Has condensation formed on the lens?</p>	<p>If the projector is suddenly taken from a cold environment to a warm environment or if sudden ambient temperature changes occur, condensation may form on the surface of the lens, and this may cause the images to appear fuzzy. Set the projector up in the room approximately one hour before it is to be used. If condensation forms, disconnect the power cord and let the projector stand for a while.</p>

● **Interference or distortion appear in images**

<p>Are the image signal format settings correct?</p>	<p>When a <u>composite video</u> or <u>S-Video</u> signal is being input. If images cannot be projected even when the "Video Signal" menu command is set to "Auto", change the setting to the signal format for the connected equipment. "Setup" - "Input Signal" - "Video Signal" (p.36)</p>
	<p>If connected to the INPUT A or INPUT B port Check that the connectors of the connection cable are inserted into the correct ports. (<i>Setup Guide</i>)</p>
<p>Are the cables connected correctly?</p>	<p>Check that all of the cables required for projection are securely connected. (<i>Setup Guide</i>)</p>
<p>Is an extension cable being used?</p>	<p>If an extension cable is used, interference may increase. Try connecting a signal amplifier.</p>
<p>Have the "Sync." and "Tracking" settings been adjusted correctly?</p> <p style="text-align: center;">Only when projecting computer images</p>	<p>The projector has an automatic adjustment function for projecting images at optimum quality. However, some types of signal may not be adjusted correctly even when the automatic adjustment function is applied. In such cases, use the "Tracking" and "Sync." menu commands to adjust the signals. "Image" - "Picture Quality" - "Tracking", "Sync." (p.30)</p>
<p>Has the correct resolution been selected?</p> <p style="text-align: center;">Only when projecting computer images</p>	<p>Set the computer so that the output signals are compatible with this projector. "List of Supported Signal Resolutions" (p.59), Computer documentation</p>

● **Image is truncated (large) or small**

<p>Has the correct aspect been selected?</p>	<p>Press the  button on the remote control or the [ASPECT] button on the projector's control panel to select the aspect that matches the input signals. (p.19) If images with subtitles are being projected using the "Zoom" command, use the "Zoom Caption" menu command to adjust. (p.33)</p>
<p>Has the "Position" setting been adjusted correctly?</p>	<p>Use the "Position" menu command to adjust. "Setup" - "Screen" - "Position" (p.33)</p>
<p>Has the computer been set for dual display?</p> <p style="text-align: center;">Only when projecting computer images</p>	<p>If dual display has been activated in the Display Properties of the computer's Control Panel, the projector will only project about half of the image on the computer screen. To display the whole of the image on the computer screen, turn off the dual display setting. Computer video driver documentation</p>
<p>Has the correct resolution been selected?</p> <p style="text-align: center;">Only when projecting computer images</p>	<p>Set the computer so that the signals that are output are compatible with this projector. "List of Supported Signal Resolutions" (p.59), Computer documentation</p>



● Image colors are not right

<p>Are the image signal format settings correct?</p>	<p>When a <u>composite video</u> or <u>S-Video</u> signal is being input. If images cannot be projected even when the "Video Signal" menu command is set to "Auto", change the setting to the signal format for the connected equipment. "Setup" - "Input Signal" - "Video Signal" (p.36)</p> <p>If the signal source is connected to the INPUT A, INPUT B or D4 port, set the "Input Signal" menu command to match the signal format for the connected equipment. "Setup" - "Input Signal" (p.36) You can also use the (A), (B) and (D4) buttons on the remote control to change the signal. (<i>Setup Guide</i>)</p>
<p>Are the cables connected correctly?</p>	<p>Check that all of the cables required for projection are securely connected. (<i>Setup Guide</i>)</p>
<p>Has the image Contrast been adjusted correctly?</p>	<p>Use the "Contrast" or "White Level" menu command to adjust. "Image" - "Picture Quality" - "Input Adjustment" (p.30)</p>
<p>Has the color been adjusted correctly?</p>	<p>Use the "Color Adjustment" menu command to adjust. "Image" - "Color Adjustment" (p.31)</p>
<p>Have the color intensity and tint been adjusted correctly?</p>	<p>Use the "Color Intensity" and "Tint" menu commands to adjust. "Image" - "Picture Quality" - "Color Intensity", "Tint" (p.30)</p>

Only when projecting images from a video source

● Images appear dark

<p>Has the image brightness been adjusted correctly?</p>	<p>Use the "Input Adjustment" or "Iris" menu commands to adjust. "Image" - "Picture Quality" - "Input Adjustment", "Iris" (p.30)</p>
<p>Has the image contrast been adjusted correctly?</p>	<p>Use the "Contrast" or "White Level" menu command to adjust. "Image" - "Picture Quality" - "Input Adjustment" (p.30)</p>
<p>Is the lamp due for replacement?</p>	<p>When the lamp is nearly due for replacement, the images will become darker and the color quality will become poorer. When this happens, the lamp should be replaced with a new one. (p.53)</p>

● Projection stops automatically



<p>Is sleep mode active?</p>	<p>If the projector is left on without any signals being input, the lamp will turn off automatically and the projector will switch to standby mode. Press the (⊗/1) button on the remote control or the [STANDBY/ON] button on the projector's control panel to turn on the power. Set to "OFF" if not using the "Sleep Mode" function. "Setup" - "Operation" - "Sleep Mode" (p.34)</p>
------------------------------	--

● Vertical interference appears in the projected images

<p>When the projector is used for long periods, vertical interference may appear in the projected images.</p>	<p>Adjust the bright portions and dark portions of the grayscale shades in the "LCD Panel Adjustment" menu. "Setup" - "Operation" - "LCD Panel Adjustment" (p.34, 56)</p>
---	---

Problems when projection starts

● Power does not turn on

Have you pressed the [Power] button?	Press the  button on the remote control or the [STANDBY/ON] button on the projector's control panel.
Is "Key Lock" set to "ON"?	If the "Key Lock" menu command is set to "ON", none of the control panel buttons will operate. Press the  button on the remote control. "Setup" - "Operation" - "Lock Setting" - "Key Lock" (p.34)
Is the  / indicator lit orange?	Disconnect the power cord and then reconnect it. (p.6) Check the circuit breaker to see if power is being supplied.
Do the indicators turn off and on when the power cord is touched?	Turn off the projector's power, disconnect the power cord and then reconnect it. If this does not fix the problem, there may be a problem with the power cord. Stop using the projector, turn off the main power switch, disconnect the power cord from the electrical outlet, and contact your nearest dealer.

Problems with the remote control

● The remote control does not work

Is the remote control light-emitting area facing towards the remote control light-receiving area when it is operated?	Face the remote control towards the remote control light-receiving area. The operating angle for the remote control is approximately $\pm 30^\circ$ horizontally and approximately $\pm 30^\circ$ vertically. (<i>Setup Guide</i>)
Is the remote control too far from the projector?	The operating distance is approximately 7 m. (<i>Setup Guide</i>)
Is direct sunlight or strong light from fluorescent lamps shining onto the remote control light-receiving area?	Set the projector up in a location where strong light will not shine onto the remote control light-receiving area.
Are the batteries dead, or have the batteries been inserted correctly?	Insert new batteries, while making sure that they face correctly. (<i>Setup Guide</i>)

Appendices

This chapter provides information on maintenance procedures to ensure the best level of performance for the projector for a long time.

Maintenance	50
• Cleaning	50
• Cleaning the Projector Case	50
• Cleaning the Lens.....	50
• Cleaning the Air Filter.....	51
• Removing the Air Filter	51
• Replacing Consumables	52
• Lamp Replacement Period	52
• Replacing the Lamp	53
• Resetting the Lamp Operating Time	55
• If vertical stripe interference appears in the projected images	56
Optional Accessories	58
List of Supported Signal Resolutions	59
• Component Video/RGB Video	59
• Composite Video/S-Video	59
• Analog-RGB signals/signals input to the HDMI port	60
• Range of compatible formats for HDMI port input signals	60
Specifications	61
Appearance	62
Part Names and Functions	63
• Front/Top	63
• Control Panel	64
• Rear	65
• Base	65
• Remote Control	66
Glossary	67

Maintenance

This section describes maintenance tasks such as cleaning the projector and replacing consumable parts.

Cleaning

You should clean the projector if it becomes dirty or if the quality of projected images starts to deteriorate.



Be sure to read the *Safety Instructions* in this manual for details on safe handling of the projector during cleaning.

Cleaning the Projector Case

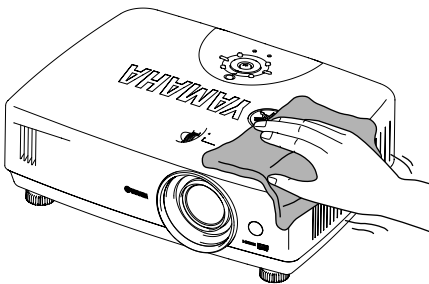

Clean the projector case by wiping it gently with a soft cloth. If the projector is particularly dirty, moisten the cloth with water containing a small amount of neutral detergent, and then firmly wring the cloth dry before using it to wipe the projector case. Then wipe the case again with a soft, dry cloth.



Do not use volatile substances such as wax, alcohol or thinner to clean the projector case. These can cause the case to warp and make the coating finish peel off.

Cleaning the Lens

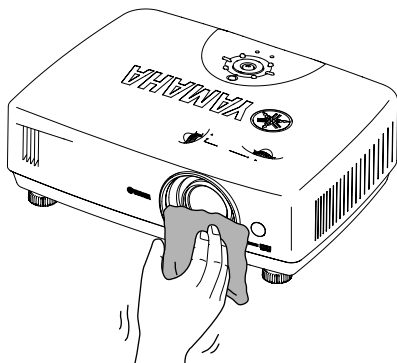

Use a commercially-available air blower, or use a lens cleaning paper to gently wipe the lens.



Do not rub the lens with harsh materials or subject the lens to shocks, as it can easily become damaged.

Cleaning the Air Filter

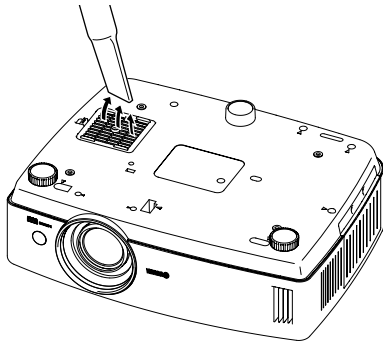

If the airfilter becomes clogged with dust or the message "The projector is overheating. Make sure nothing is blocking the air vent, and clean or replace the air filter." is displayed, clean the air filter.

Turn the projector upside-down and use a vacuum cleaner to clean the air filter.

* Do not use water or detergents to clean the air filter.



- If the air filter becomes clogged with dust, it can result in overheating which may cause operating problems or reduce the operating life of the optical parts. It is recommended that you clean the air filter about once every three months. If using the projector in a dusty location, the air filter should be cleaned more often.
- If the air filter replacement message above appears frequently, consult your dealer.

Removing the Air Filter

If the air filter is particularly dirty, remove it and clean it if required.

1

Turn off the power, wait for the cool-down period to end (takes approximately 30 seconds), and then disconnect the power cord.

2

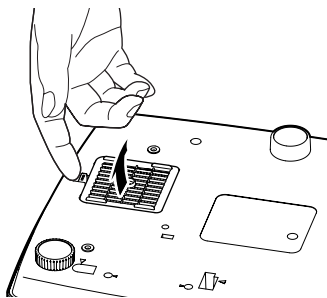

Remove the air filter cover.

Push the clasp of the air filter cover with your finger and pull it upward.

3

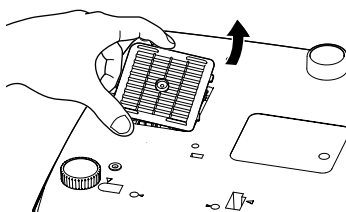

Remove the air filter.

Put your finger under the rib at one side of the air filter and lift it up. Use a vacuum cleaner to remove any dust from the air filter.

4

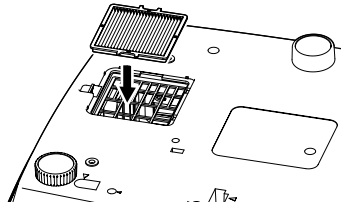

Install the air filter.

Install the air filter so that it faces the correct way.

5

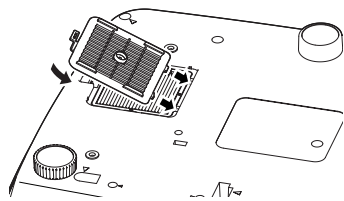

Install the air filter cover.

Replacing Consumables

This section explains how to replace the lamp.

Lamp Replacement Period

It is time to replace the lamp when:

- The message "Lamp Replace" appears on the screen when projection starts.

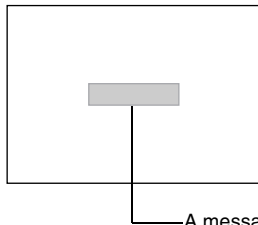

The message appears for 30 seconds, and disappears again after 30 seconds have passed.

A message will be displayed.

- The LAMP/COVER indicator flashes orange or lights red.

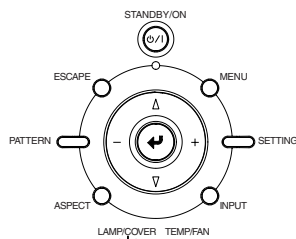

Lamp indicator flashes orange or lights red.

- If the brightness and image quality is less than it was in the beginning or if flickering has increased.



- The lamp replacement warning message is set to appear after approximately 1600 hours of lamp use in order to maintain the brightness and quality of the projected images. The time taken for the message to be displayed will vary depending on factors such as the lamp power setting and the picture mode setting.
If you continue to use the lamp after this period, the possibility of the lamp breaking becomes greater.
When the lamp replacement message appears, replace the lamp with a new one as soon as possible, even if it is still working.
- The actual life of each individual lamp will vary depending on the characteristics of the lamp and on the way it has been used. The lamp may become dark or be off even before the lamp replacement message appears. You should always have a spare lamp ready in case it is needed.
- Contact your dealer for a spare lamp.

Replacing the Lamp



- If the lamp stops working and needs to be replaced, it could have been broken.
If replacing the lamp of a projector which has been installed to the ceiling, you should remove the projector from the ceiling before replacing the lamp.
- Wait for the lamp to cool down sufficiently before removing the lamp cover. It takes approximately one hour after the **cool-down** period has finished before the lamp is cool enough to be removed.

1

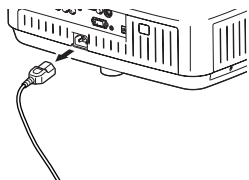

Turn off the power, wait for the cool-down period to finish (takes approximately 30 seconds), then disconnect the power cord.

* Wait until the lamp cools down (takes approximately 1 hour).

2

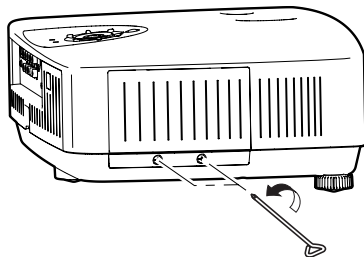

Loosen the screws fixing the lamp cover.

3

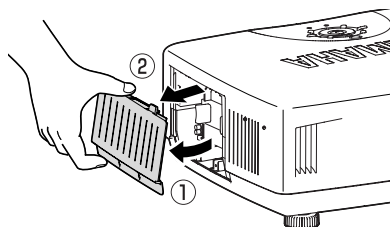

Remove the lamp cover.

Lift the lamp cover up slightly from the bottom to remove it.

4

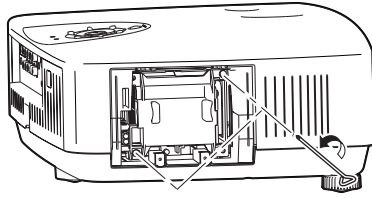

Loosen the screws fixing the lamp.

5

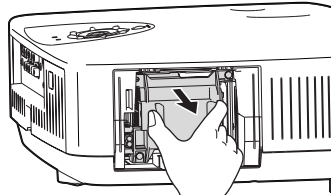

Remove the old lamp.
Pull the lamp out straight.

6

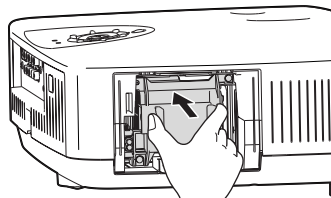

Install the new lamp.
Securely insert the lamp so that it is facing correctly.

7

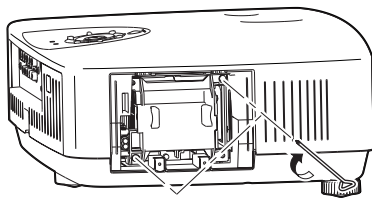

Securely tighten the lamp fixing screws.

8

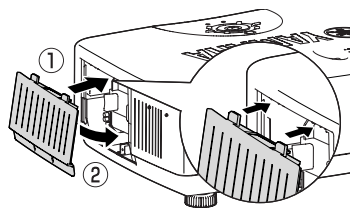

Install the lamp cover, then tighten the lamp cover fixing screws.



- Install the lamp securely. For safety, the lamp will turn off automatically when the lamp cover is opened. Moreover, the lamp will not turn on if the lamp or the lamp cover is not installed correctly.
- This product contains a high intensity lamp that contains a small amount of mercury. Disposal of this material may be regulated due to environmental considerations. For disposal information in the United States, refer to the Electronic Industries Alliance web site: www.eiae.org

Resetting the Lamp Operating Time

The lamp operating time must always be reset after the lamp has been replaced with a new one. The projector has a built-in lamp operating time counter.

A replacement message is displayed when the counter reaches a certain amount.



Do not reset the lamp operating time except after the lamp has been replaced, otherwise the lamp replacement period will not be indicated correctly.

1

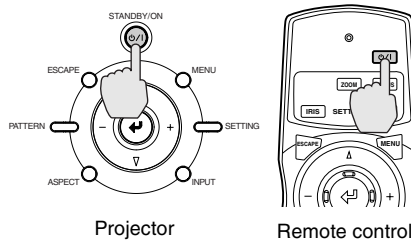

Press the [STANDBY/ON] button on the projector's control panel or the  button on the remote control.

2

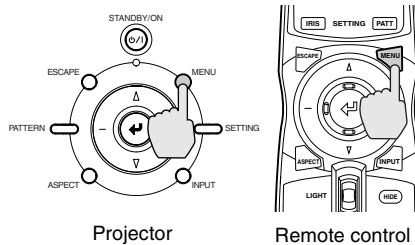



Press the [MENU] button on the projector's control panel or the  button on the remote control.

The menu will be displayed.

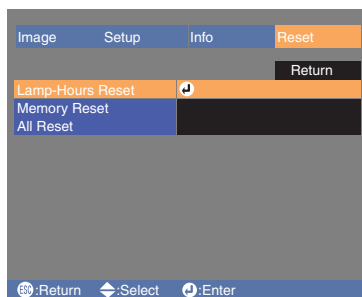
3





Select "Lamp Hours Reset" from the "Reset" menu.

Press the  button on the projector's control panel or the  button on the remote control.

4



Reset the lamp operating time.

Select "Yes", and then press the  button on the projector's control panel or the  button on the remote control.

If vertical stripe interference appears in the projected images

Vertical stripe interference may appear in the projected images at times. If this vertical stripe interference impairs image viewing, the images can be adjusted by carrying out the following procedure.

Example

Image with vertical stripe interference

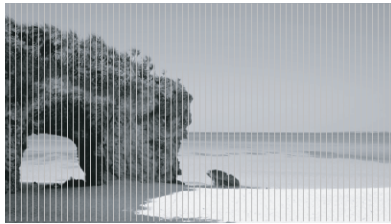

Image after adjustment



Note the following points when carrying out the procedure below.

- Turn on the power and let the projector stand for approximately 10 minutes after the lamp turns on before starting the following procedure.
- The following adjustment can be carried out more effectively if the room is made dark beforehand.
- The adjustment can also be carried out without an image source connected.
- If the vertical stripe interference becomes a problem again while using the projector after the adjustment has been carried out, you can repeat the adjustment procedure to maintain clear images.

1



Press the [MENU] button on the projector's control panel or the button on the remote control.



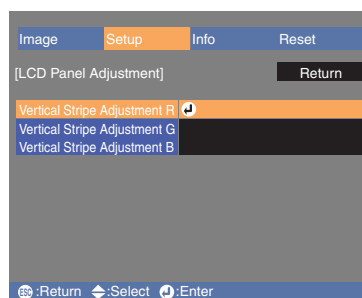

The menu will be displayed. Select "Setup" - "Operation" - "LCD Panel Adjustment".

2



Adjust the vertical stripe setting for each R/G/B color component.

First select "Vertical Stripe Adjustment R" and then press the  button on the projector's control panel or the  on the remote control.

The red tone adjustment screen will be displayed.

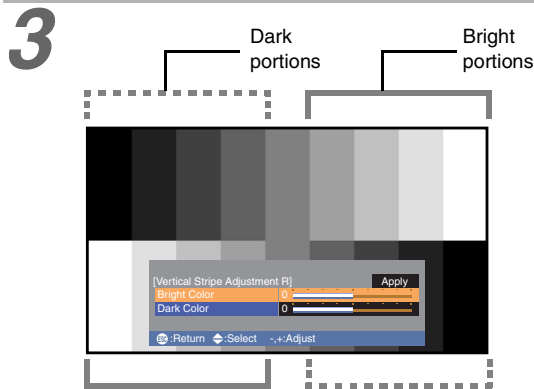

While checking the tone adjustment screen, adjust the settings starting from the one where the vertical stripe interference is most noticeable. If the stripes are most noticeable in the bright portions of the image, adjust the "Bright Color" setting first.

After this, adjust the "Dark Color" setting while checking the tone adjustment screen to fix the vertical stripe interference in the darker portions of the image.

Once both adjustments have been completed, select "Apply" and then press on the projector's control panel or on the remote control.

4

Repeat steps 2 and 3 to adjust the "Vertical Stripe Adjustment G" and "Vertical Stripe Adjustment B" settings.

5

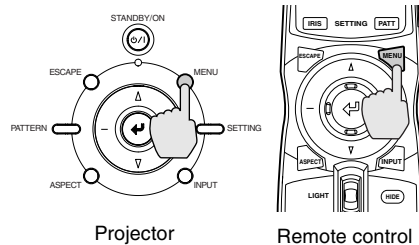

Once all adjustments have been completed, press [MENU] on the projector's control panel or on the remote control to exit the configuration menu.

Optional Accessories

The following options are available for using with the projector. The availability of these options is subject to change without prior notice.

Lamp cartridge	PJL-520
Use as a replacement for spent lamps.	
Ceiling mount bracket (for low ceilings) *	PMT-L51
Use when installing the projector to a low ceiling.	
Ceiling mount bracket (for high ceilings) *	PMT-H55
Use when installing the projector to a high ceiling.	

*A special method of installation is required in order to suspend the projector from the ceiling. Please contact the place of purchase if you would like to use this installation method.

List of Supported Signal Resolutions

Depending on the "Overscan" settings, the values given below will change slightly.

Component Video/RGB Video

4:3 16:9 :Aspect Units: dots

Signal	Resolution	Aspect mode					
		Normal	Squeeze	Zoom	Through	Squeeze through	Smart Zoom
SDTV (480i, 60Hz) (D1)	640 × 480 (640 × 360) (for zoom)	960 × 720 4:3	1280 × 720 16:9	1280 × 720 16:9	596 × 446 4:3	794 × 446 16:9	1280 × 760 16:9
SDTV (576i, 50Hz)	768 × 576 (768 × 432) (for zoom)	960 × 720 4:3	1280 × 720 16:9	1280 × 720 16:9	708 × 528 4:3	944 × 528 16:9	1280 × 760 16:9
SDTV (480p) (D2)	640 × 480 (640 × 360) (for zoom)	960 × 720 4:3	1280 × 720 16:9	1280 × 720 16:9	596 × 446 4:3	794 × 446 16:9	1280 × 760 16:9
SDTV (576p)	768 × 576 (768 × 432) (for zoom)	960 × 720 4:3	1280 × 720 16:9	1280 × 720 16:9	708 × 528 4:3	944 × 528 16:9	1280 × 760 16:9
HDTV (720p) 16:9 (D4)	1280 × 720	1280 × 720 16:9	–	–	1176 × 664 16:9	–	–
HDTV (1080i) 16:9 (D3)	1920 × 1080	1280 × 720 16:9	–	–	–	–	–

Composite Video/S-Video

4:3 16:9 :Aspect Units: dots

Signal	Resolution	Aspect mode					
		Normal	Squeeze	Zoom	Through	Squeeze through	Smart Zoom
TV (NTSC)	640 × 480 (640 × 360) (for zoom)	960 × 720 4:3	1280 × 720 16:9	1280 × 720 16:9	596 × 446 4:3	794 × 446 16:9	1280 × 720 16:9
TV (PAL, SECAM)	768 × 576 (768 × 432) (for zoom)	960 × 720 4:3	1280 × 720 16:9	1280 × 720 16:9	708 × 528 4:3	944 × 528 16:9	1280 × 720 16:9

Analog-RGB signals/signals input to the HDMI port

Units: dots

Signal	Resolution	Aspect mode					
		Normal	Squeeze	Zoom	Through	Squeeze Through	Smart Zoom
VGA▶▶ 60 , SDTV▶▶ (480p)	640 × 480 (640 × 360) (for zoom)	960 × 720	1280 × 720	1280 × 720	640 × 480	853 × 480	1280 × 720
VESA 72/75/85	640 × 480 (640 × 360) (for zoom)	960 × 720	1280 × 720	1280 × 720	640 × 480	853 × 480	1280 × 720
SVGA▶▶ 56/60/ 72/75	800 × 600 (800 × 450) (for zoom)	960 × 720	1280 × 720	1280 × 720	800 × 600	1066 × 600	1280 × 720
XGA▶▶ 43i/60/70/75	1024 × 768 (1024 × 576) (for zoom)	960 × 720	1280 × 720	1280 × 720	–	–	1280 × 720
MAC13"	640 × 480	960 × 720	1280 × 720	1280 × 720	640 × 480	853 × 480	1280 × 720
MAC16"	832 × 624	960 × 720	1280 × 720	1280 × 720	832 × 624	1109 × 624	1280 × 720
MAC19"	1024 × 768	960 × 720	1280 × 720	1280 × 720	–	–	1280 × 720
SDTV (480i, 60Hz)	640 × 480 (640 × 360) (for zoom)	960 × 720	1280 × 720	1280 × 720	640 × 480	853 × 480	1280 × 720
SDTV (576i, 50Hz)	768 × 576 (768 × 432) (for zoom)	960 × 720	1280 × 720	1280 × 720	768 × 576	1024 × 576	1280 × 720
SDTV (576p)	768 × 576 (768 × 432) (for zoom)	960 × 720	1280 × 720	1280 × 720	768 × 576	1024 × 576	1280 × 720
HDTV (720p)	1280 × 720	1280 × 720	–	–	1280 × 720	–	–
HDTV (1080i)	1920 × 1080	1280 × 720	–	–	–	–	–

MAC signals are only supported in analogue format.

■ correspond to input signals from the HDMI port.

It may be possible to project signals which are not listed in the above table. However, some functions may be limited in that case.

Range of compatible formats for HDMI port input signals

- 640 × 480p @ 59.94/60Hz
- 1280 × 720p @ 59.94/60Hz
- 1920 × 1080i @ 59.94/60Hz
- 720 × 480p @ 59.94/60Hz
- 720 (1440) × 480i @ 59.94/60Hz
- 1280 × 720p @ 50Hz
- 1920 × 1080i @ 50Hz
- 720 × 576p @ 50Hz
- 720 (1440) × 576i @ 50Hz

Specifications

Product name	LPX-510 Home cinema projector		
Dimensions	440 (W) x 137 (H) x 321 (D) mm (17.3 (W) x 5.39 (H) x 12.6 (D) inches) (not including protruding parts)		
Panel size	17.8mm (0.7 inches)		
Display method	Polysilicon TFT active matrix		
Drive method	Full-line 12-phase block sequential writing		
Resolution	921,600 pixels (1280 (W) x 720 (H) dots) x 3		
Focus adjustment	Electronic type		
Zoom adjustment	Electronic type (approx. 1:1.5)		
Lamp (light source)	UHE lamp, 200 W, Model No.: P JL-520		
Power supply	100 – 120 V, 50/60 Hz AC, 290W During standby: 0.4 W (RS-232C Off) 200 – 240 V, 50/60 Hz AC, 290W 3 W (RS-232C On)		
Operating temperature	+5°C – +35°C (41°F - 95°F) (However, no condensation should form)		
Storage temperature	-10°C – +60°C (14°F - 140°F) (However, no condensation should form)		
Weight	Approx. 6.3 kg (14 lbs)		
Connectors	HDMI	1	HDMI
	INPUT A	1	5RCA pin jack
	INPUT B	1	5RCA pin jack
	VIDEO	1	RCA pin jack
	S VIDEO	1	Mini DIN 4-pin
	D4	1	D4
	RS-232C	1	D-Sub 9-pin (male)
	TRIGGER OUT	1	DC jack



Pixelworks DNX™ ICs are used in this Projector.

Appearance

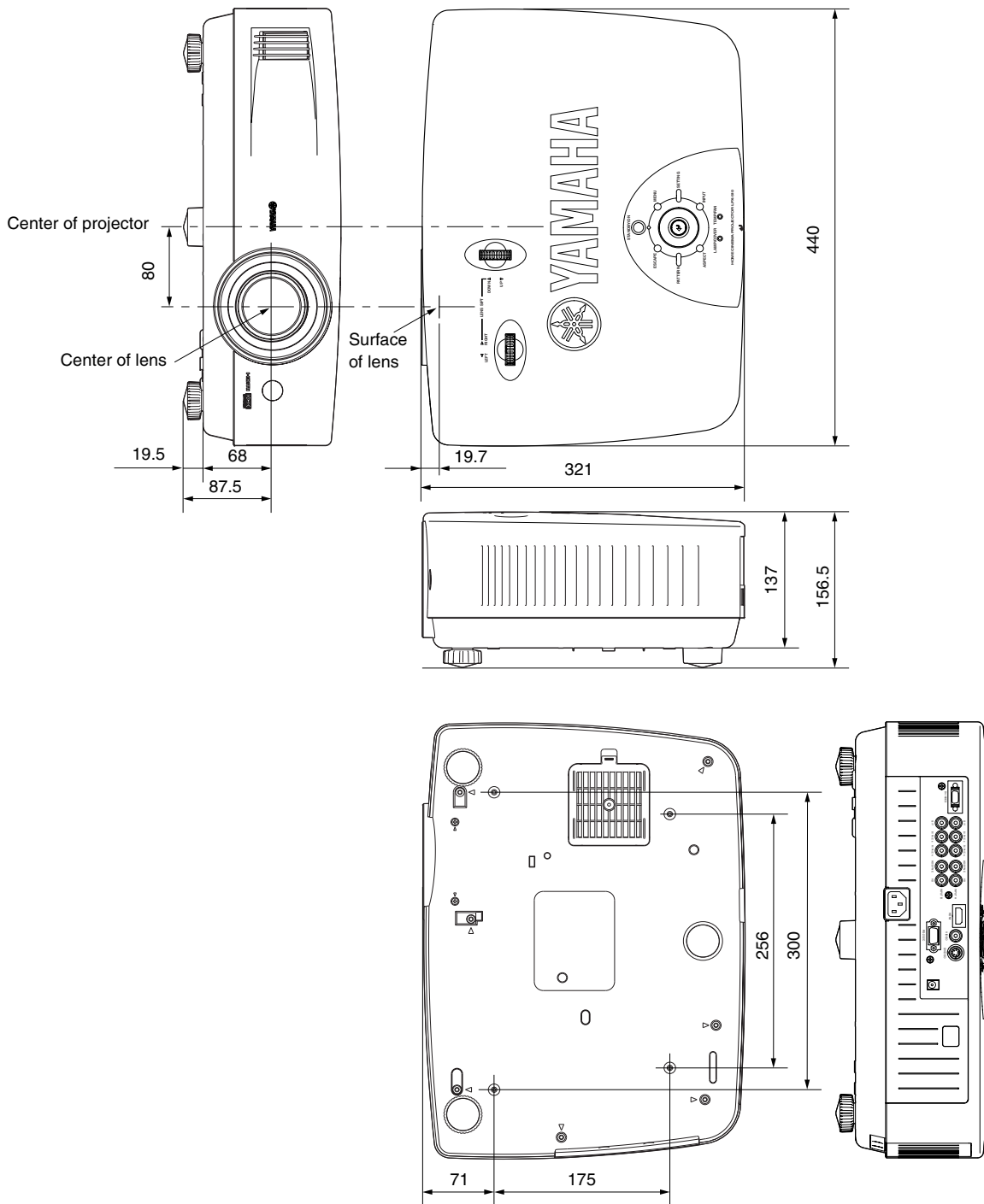

*Center of lens = Default lens shift position

Units: mm

Part Names and Functions

Front/Top

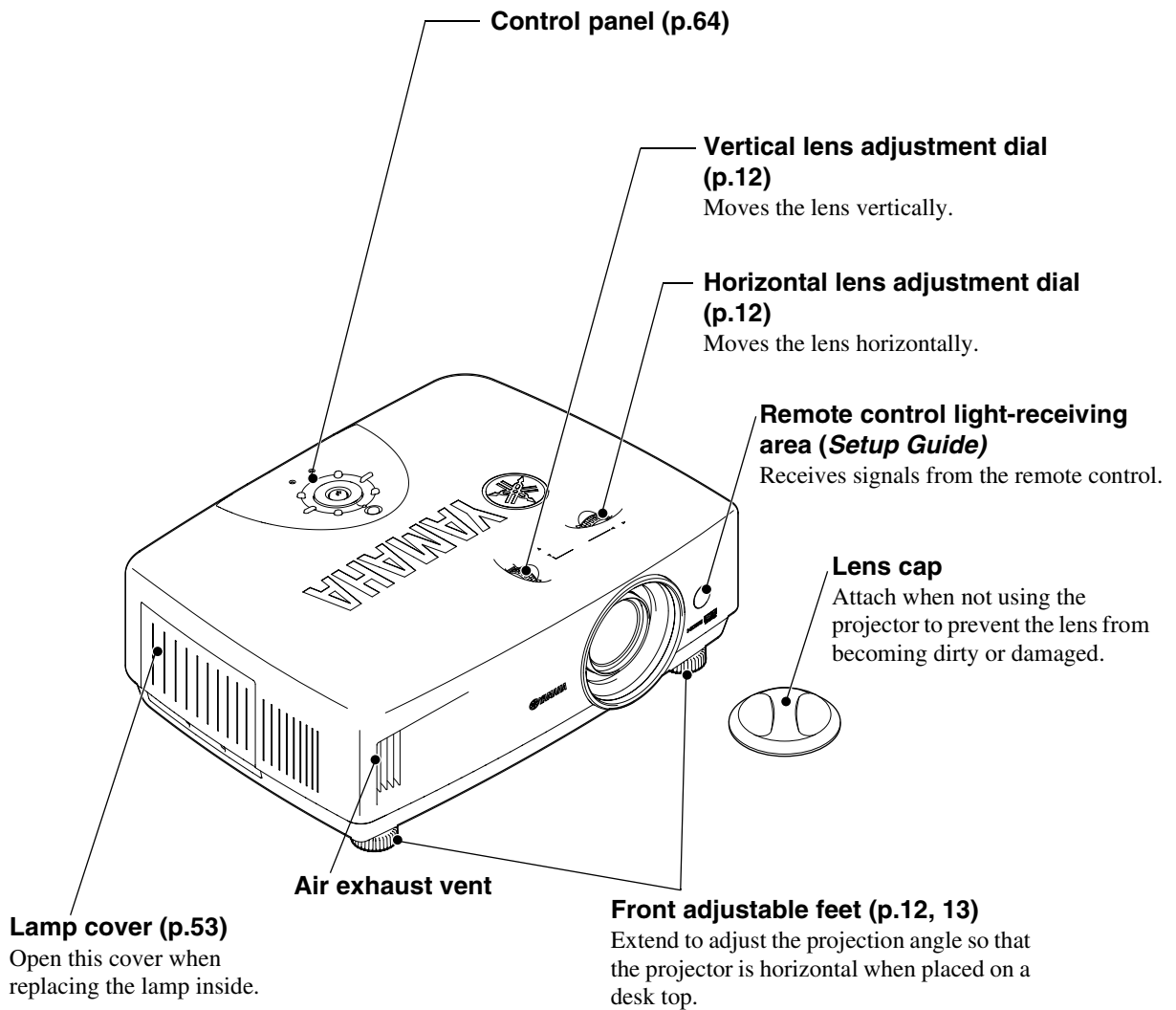

Control Panel

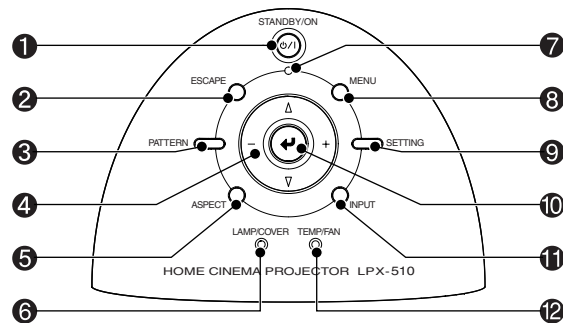

1 [STANDBY/ON] button (p.7, 9)

Press to turn the projector's power on and off.

2 [ESCAPE] button (p.11, 16, 17, 38, 39)

When pressed while a menu or selection menu is being displayed, the screen changes to the previously-displayed menu.

3 [PATTERN] button (p.14)

Displays a selection menu for selecting a test pattern.

4 Δ / ∇ / - / + buttons (p.11, 13, 14, 16, 37, 38, 39)

Used to select menu commands and change adjustment values.

5 [ASPECT] button (p.19)

Displays a selection menu for selecting the aspect.

6 LAMP/COVER indicator (p.42)

Lights or flashes in different colors to indicate problems with the projection lamp.

7 ⏻ / | indicator (p.6, 7, 42)

Flashes or lights in different colors to indicate the operating status of the projector.

8 [MENU] button (p.18, 26, 37, 38, 39)

The full menu is displayed and cleared each time this button is pressed.

9 [SETTING] button (p.11, 16, 17)

Selects the lens adjustment mode. The adjustment mode changes in the order of zoom → focus → iris each time the button is pressed. Adjustment modes that have been set to lock will not be displayed.

10 ⏪ button (p.14, 18, 19, 27, 37, 38, 39)

Displays the line menu. When pressed while a menu or selection menu is being displayed, a menu command is selected and the next menu is then displayed.

11 [INPUT] button (p.7)

Displays a selection menu for selecting the image source.

12 TEMP/FAN indicator (p.42)

Lights or flashes in different colors to indicate problems with the projector's internal temperature.

Rear

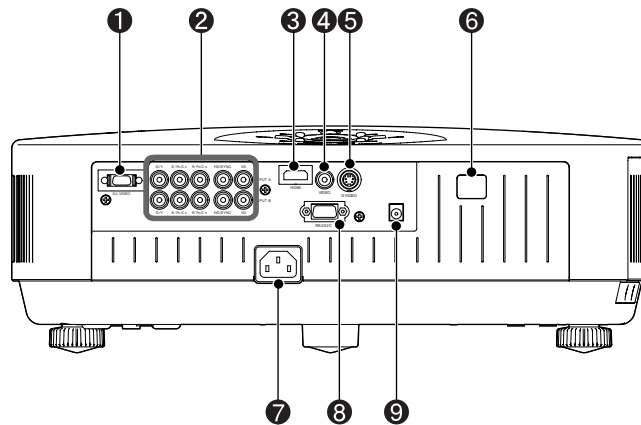
**① D4 VIDEO port (Setup Guide)**

Connects to the component video ports or D port of other video equipment.
(Japan only)

② INPUT A/INPUT B ports (Setup Guide)

Connects to the component video ports or RGB ports of other video equipment or to a computer's video output port.

③ HDMI port (Setup Guide)

Connects to video equipment or a computer that is HDMI-compatible.

④ VIDEO port (Setup Guide)

Connects to general video ports of other video equipment.

⑤ S VIDEO port (Setup Guide)

Inputs an S-Video signal to the projector from other video equipment.

⑥ Remote control light-receiving area (Setup Guide)

Receives signals from the remote control.

⑦ Power inlet (p.6, 9)

Connects the power cord.

⑧ RS-232C port

Connects to the projector to a computer using an RS-232C cable.
This port is for service use, and should not normally be used.

⑨ TRIGGER OUT port (p.34)

This is for output of signals that are used by an external device to control the projector.

Base

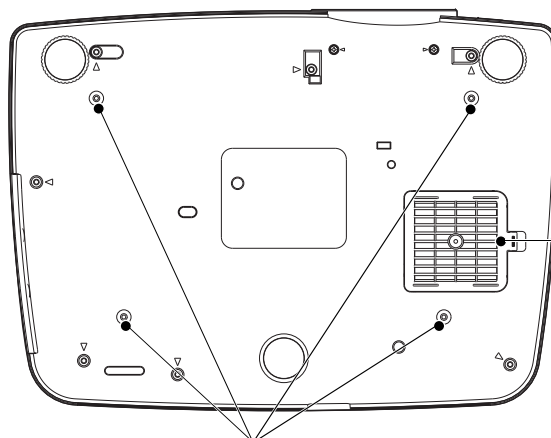
**Air Filter (air inlet) (p.51)**

Prevents dust and other foreign particles from being drawn into the projector. It should be cleaned periodically.

Suspension bracket fixing points (4 points) (p.58)

Attach the optional ceiling mount here when suspending the projector from a ceiling.

Remote Control

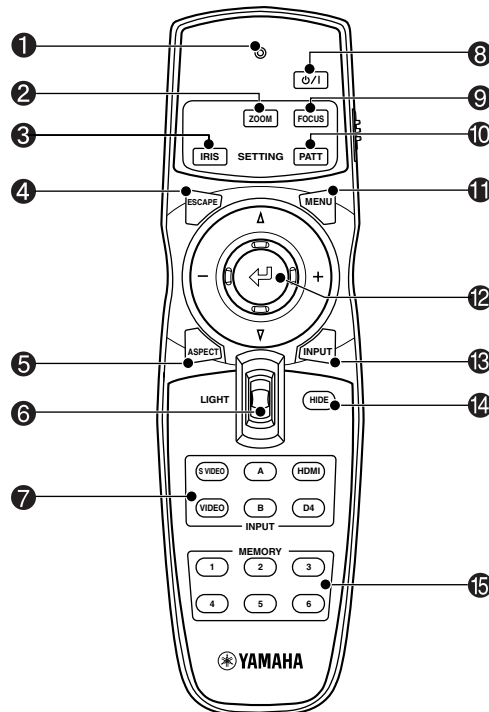

1 Indicator

Illuminates when remote control signals are being output.

2 [Zoom] button (p.11)

Press to adjust the size of projected images.

3 [IRIS] button (p.17)

Press to adjust the brightness of images using the lens aperture.

4 [ESCAPE] button (p.38, 39)

When pressed while a menu or selection menu is being displayed, the screen changes to the previously-displayed menu.

5 [ASPECT] button (p.19)

Displays a selection menu for selecting the aspect.

6 [LIGHT] switch (Setup Guide)

When the switch is tilted up or down, the [ESCAPE], [ASPECT], [MENU] and [INPUT] buttons light. After approximately 10 seconds have passed, the illumination automatically turns off.

7 [INPUT] button (p.7)

Lets you select the input port directly. The [A] and [B] buttons change the "Input Signal" setting in the order COMPONENT → RGB TV → RGB PC each time a button is pressed.

8  button (p.7, 9)

Press to turn the projector's power on and off.

9 [Focus] button (p.16)

Press to adjust the focus of the projection lens.

10 [PATT] button (p.14)

Displays a selection menu for selecting a test pattern.

11 [MENU] button (p.18, 26, 37, 38, 39)

The menus turn on and off each time the [Menu] button is pressed.

12  button (p.11, 14, 16, 17, 18, 19, 27, 37, 38, 39)

Press to display the line menu. When tilted vertically or horizontally while a menu or selection menu is being displayed, a menu command is selected, and if the button is pressed, the selected command is executed or confirmed.

13 [INPUT] button (p.7)

Displays a selection menu for selecting the image source.

14 [HIDE] button (p.35)

The projected images switch off and on each time the [HIDE] button is pressed. When the images are switched off, the screen will appear in accordance with the setting made using the "Hide Screen" command in the "Setup" menu.

However, the video playback still continues while moving images are paused, so image playback will not resume exactly from the point where playback was paused.

15 [MEMORY] button (p.27)

Retrieves the settings stored using the "Memory Save" command in the "Image" menu and applies them to the projected images.

Glossary

Following is an explanation of some of the terms used in this guide which may be unfamiliar or which were not explained in the manual itself. Further information can be obtained by referring to other commercially-available publications.

Component video	Video signals which have the video brightness signals and color signals separated, in order to provide better image quality. In high-definition TV (HDTV), it refers to images which consist of three independent signals: Y (luminance signal), and Pb and Pr (color difference signals).
Composite video	Video signals which have the video brightness signals and color signals mixed together. The type of signals commonly used by household video equipment (NTSC, PAL and SECAM formats). Video signals which consist of a carrier signal Y (luminance signal) within the color bar signal, and a chroma or color signal (CbCr).
Cool-down	This is the process by which the projector's lamp is cooled down after it has become hot through use. It is carried out automatically when the [Power] button on either the remote control or the projector's control panel has been pressed to the projector off. Do not disconnect the power cord while cool-down is in progress, otherwise the cool-down process will not work properly. If the cool-down period is not allowed to finish normally, the projector's lamp and internal components will remain at high temperatures, and this may shorten the useful life of the lamp or cause problems with the operation of the projector. The cool-down period lasts for about 30 seconds. The actual time will vary depending on the external air temperature.
DCDi function	An abbreviation for Directional Correlational Deinterlacing. Refers to a high-resolution image circuit function developed by Faroudja. It incorporates the latest in edge cutting technology to smooth the jaggedness from the edges of images that have been converted from interlaced to progressive video, in order to provide more natural images.
HDMI	An abbreviation for High Definition Multimedia Interface, and refers to a standard for digital transmission of high-definition images and multi-channel audio signals. HDMI is a standard that is targeted towards household digital equipment and computers that allows digital signals to be transmitted in their original high quality without compression, and it also includes a digital signal encryption function.
HDTV	An abbreviation for High-Definition Television. It refers to high-definition systems which satisfy the following conditions. <ul style="list-style-type: none"> • Vertical resolution of 720p or 1080i or greater (p = progressive, i = interlaced) • Screen aspect of 16:9 • Dolby Digital audio reception and playback (or output)
Interlace	A method of image scanning whereby the signal bandwidth used is approximately half that required for sequential scanning when images with the same still picture resolution are broadcast.
NTSC	An abbreviation for National Television Standards Committee, and a format for ground-based analogue color television broadcasts. This format is used in North America, Japan, and Central and South America.
PAL	An abbreviation for Phase Alternation by Line, and a format for ground-based analogue color television broadcasts. This format is used in Western European countries except France, and also in Asian countries such as China and in Africa.
Refresh rate	The light-emitting element of a display maintains the same luminosity and color for an extremely short time. Because of this, the image must be scanned many times per second in order to refresh the light emitting element. The number of refresh operations per second is called the "refresh rate", and is expressed in hertz (Hz).
S-Video	A video signal which has the luminance component and color component separated in order to provide better image quality. It refers to images which consist of two independent signals: Y (luminance signal), and C (color signal).
SDTV	An abbreviation for Standard Definition Television. It refers to standard television systems which do not satisfy the conditions for HDTV.
SECAM	An abbreviation for Sequential Couleur A Memoire, and a format for ground-based analogue color television broadcasts. This format is used in France, Eastern Europe and the former Soviet Union, the Middle East and Africa.
sRGB	An international standard for color intervals that was formulated so that colors which are reproduced by video equipment can be handled easily by computer operating systems (OS) and the Internet.
SVGA	A type of image signal with a resolution of 800 (horizontal) × 600 (vertical) dots which is used by IBM PC/ AT-compatible computers.

Sync. (Synchroni- zation)	The signals output from computers have a specific frequency. If the projector frequency does not match this frequency, the resulting images will not be of a good quality. The process of matching the phases of these signals (the relative position of the crests and troughs in the signal) is called "synchronization". If the signals are not synchronized, problems such as flickering, blurriness and horizontal interference can occur.
Tracking	The signals output from computers have a specific frequency. If the projector frequency does not match this frequency, the resulting images will not be of a good quality. The process of matching the frequency of these signals (the number of crests in the signal) is called "tracking". If tracking is not carried out correctly, wide vertical stripes will appear in the projected images.
VGA	A type of image signal with a resolution of 640 (horizontal) × 480 (vertical) dots which is used by IBM PC/ AT-compatible computers.
XGA	A type of image signal with a resolution of 1,024 (horizontal) × 768 (vertical) dots which is used by IBM PC/ AT-compatible computers.

All rights reserved. No part of this publication may be reproduced, stored in a retrieval system, or transmitted in any form or by any means, electronic, mechanical, photocopying, recording, or otherwise, without the prior written permission of YAMAHA CORPORATION. No patent liability is assumed with respect to the use of the information contained herein. Neither is any liability assumed for damages resulting from the use of the information contained herein.

Neither YAMAHA CORPORATION nor its affiliates shall be liable to the purchaser of this product or third parties for damages, losses, costs, or expenses incurred by purchaser or third parties as a result of: accident, misuse, or abuse of this product or unauthorized modifications, repairs, or alterations to this product, or (excluding the U.S.) failure to strictly comply with YAMAHA CORPORATION's operating and maintenance instructions.

YAMAHA CORPORATION shall not be liable against any damages or problems arising from the use of any options or any consumable products other than those designated as Original YAMAHA Products or YAMAHA Approved Products by YAMAHA CORPORATION.

General Notice: The following trademarks and registered trademarks are the property of their respective owners and are used in this publication for identification purposes only.

Macintosh, Mac, and iMac are registered trademarks of Apple Computer, Inc.

IBM is a registered trademark of International Business Machines Corporation.

Windows and Windows NT are trademarks of Microsoft Corporation in the United States of America.

Pixelworks and DNX are trademarks of Pixelworks, Inc.

"DCDi[®] by Faroudja" is a registered trade mark of Genesis Microchip Inc.

Other product names used herein are also for identification purposes only and may be trademarks of their respective owners. YAMAHA disclaims any and all rights in those marks.



©2004 YAMAHA CORPORATION All rights reserved.

YAMAHA ELECTRONICS CORPORATION, USA 6660 ORANGETHORPE AVE., BUENA PARK, CALIF. 90620, U.S.A.
YAMAHA CANADA MUSIC LTD. 135 MILNER AVE., SCARBOROUGH, ONTARIO M1S 3R1, CANADA
YAMAHA ELECTRONIK EUROPA G.m.b.H. SIEMENSSTR. 22-34, 25462 RELLINGEN BEI HAMBURG, FR. OF GERMANY
YAMAHA ELECTRONIQUE FRANCE S.A. RUE AMBROISE CROIZAT BP70 CROISSY-BEAUBOURG 77312 MARNE-LA-VALLÉE CEDEX02, FRANCE
YAMAHA ELECTRONICS (UK) LTD, YAMAHA HOUSE, 200 RICKMANSWORTH ROAD WATFORD, HERTS WD18 7GQ, ENGLAND
YAMAHA SCANDINAVIA A.B. J A WETTERGRENS GATA 1, BOX 30053, 400 43 VÄSTRA FRÖLUNDA, SWEDEN
YAMAHA MUSIC AUSTRALIA PTY, LTD. 17-33 MARKET ST., SOUTH MELBOURNE, 3205 VIC., AUSTRALIA

YAMAHA CORPORATION
Printed in Japan WC88420



Home Cinema Projector

Setup Guide

LPX-510

ENGLISH

1 Before Using the Remote Control

- Inserting the batteries and replacement period
- Using the remote control and remote operating range

2 Setup

- Screen Size and Setting-up Distance
- Setting-up Methods

3 Connecting to a home theater system

4 Connecting to a Computer

1

Before Using the Remote Control

Inserting the batteries and replacement period

The batteries are not inserted into the remote control at the time of purchase. You will first need to insert the accessory batteries into the remote control.

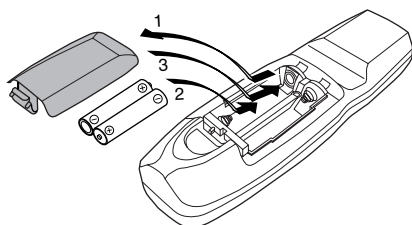

- 1 Remove the battery compartment cover.**
While pushing the catch, lift the battery cover up.
- 2 Insert the batteries.**
Make sure the polarities of the batteries are correct.
- 3 Replace the battery compartment cover.**
After inserting the tab of the battery cover, push the cover down until it clicks into place.

Battery Replacement Period

If the remote control becomes slow in responding or if it stops working, the batteries may be spent. If this happens, replace the batteries with fresh ones.

Use the following type of batteries as replacements.

Battery (AA) x 2

Using the remote control and remote operating range

[LIGHT] (illumination) switch

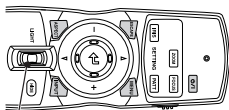

[LIGHT] switch

When the [LIGHT] switch is tilted up or down, the buttons with indicators shown in the illustration at left will light for approximately 10 seconds. If the [LIGHT] switch is tilted up or down while the buttons are lit, they will stay lit for a further 10 seconds.

Use the remote control within the ranges indicated below. If the distance or angle between the remote control and the remote control light-receiving area is outside the normal operating range, the remote control may not work.

Operating distance	Operating angle
Approx. 7 m (23 ft)	Approx. 30° vertically and horizontally

Point the remote control light-emitting area toward one of the remote control light-receiving area on the projector and operate the remote control buttons.
Approx. $\pm 30^\circ$ horizontally

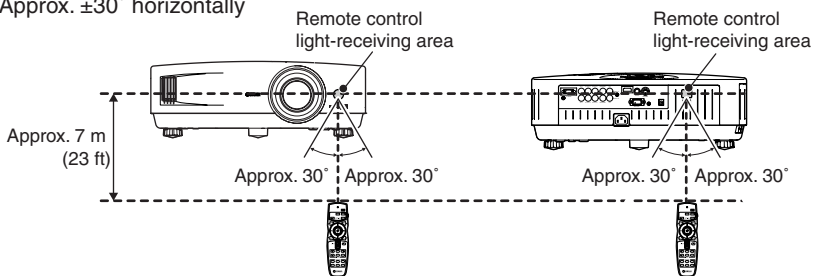

Approx. $\pm 30^\circ$ vertically

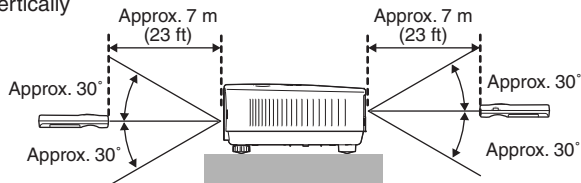

Do not allow sunlight or light from fluorescent lamps to shine directly onto the projector's remote control light-receiving area, otherwise it may interfere with the reception of signals from the remote control.

Screen Size and Setting-up Distance

The projection size will vary depending on the projection distance from the projector's lens to the screen.

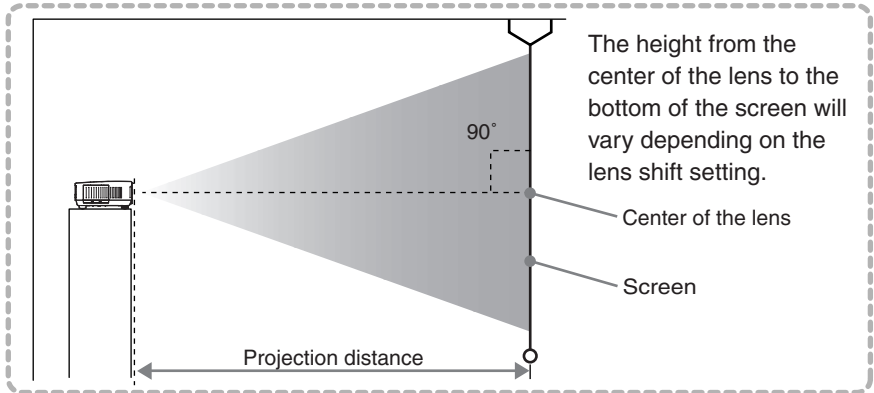

Refer to the table below to the projector so that the images are projected onto the screen at the optimum size.

Units: cm (in.)		Units: cm (ft.)	
16:9 screen size		Projection distance	
		Shortest (Zoom adjustment: Wide)	Longest (Zoom adjustment: Tele)
30"	66 × 37 (26 × 14)	87–133 (2.9–4.4)	
40"	89 × 50 (34 × 19)	118–179 (3.9–5.9)	
60"	130 × 75 (52 × 29)	179–270 (5.9–8.9)	
70"	154 × 87 (61 × 34)	209–316 (6.9–10.4)	
80"	180 × 100 (69 × 39)	240–361 (7.9–11.9)	
100"	220 × 120 (87 × 49)	301–452 (9.9–14.8)	
200"	440 × 250 (174 × 98)	606–909 (19.9–29.8)	
300"	660 × 370 (261 × 147)	911–1365 (29.9–44.8)	

Units: cm (in.)		Units: cm (ft.)	
4:3 screen size		Projection distance	
		Shortest (Zoom adjustment: Wide)	Longest (Zoom adjustment: Tele)
30"	61 × 46 (24.0 × 18.1)	108–164 (3.6–5.4)	
40"	81 × 61 (31.9 × 24.0)	146–220 (4.8–7.2)	
60"	120 × 90 (47.2 × 35.4)	221–332 (7.2–10.9)	
70"	142 × 106 (55.9 × 42.0)	258–388 (8.5–12.7)	
80"	160 × 120 (63.0 × 47.2)	295–443 (9.7–14.6)	
100"	200 × 150 (78.7 × 59.1)	370–555 (12.2–18.2)	
200"	410 × 300 (161.4 × 118.1)	745–1114 (24.4–36.5)	
300"	610 × 460 (240.2 × 181.1)	1119–1672 (36.7–54.9)	



- At the time of shipment from the factory, the vertical lens shift position is set to the lowest position, so move it to the center position before carrying out adjustment.
- The projector's lens allows a zoom ratio of up to about 1.5. The image size at the maximum zoom setting is about 1.5 times bigger than the image size at the minimum zoom setting.
- The image size will be reduced when keystone correction is carried out.

Setting-up Methods

The projector supports the following 4 projection methods, allowing you to choose the best method for displaying your images. After setting up the projector, refer to the **OWNER'S MANUAL** for details on turning on the power and adjusting settings such as the screen size. ("Basic Operations" in **OWNER'S MANUAL**)



Be sure to read "Caution" in **OWNER'S MANUAL** for details on safe handling when setting up the projector.

Front projection

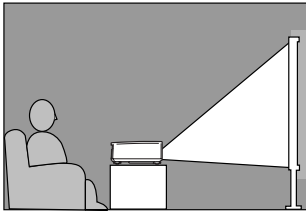

Front/ceiling projection

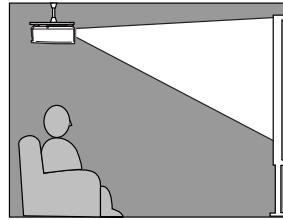

Rear projection using a translucent screen

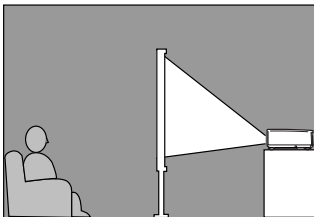

Rear projection onto a translucent screen with the projector installed to the ceiling

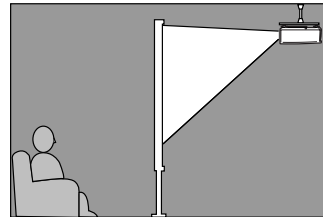

*1 If the projector is projecting from above or below the screen or from the side of the screen, use the lens shift function to adjust the image projection position. (**OWNER'S MANUAL** "Adjusting the screen image" → Adjusting the projection position (lens shift))

*2 When installing to the ceiling or projecting from behind the screen, set the "Projection" command in the menu ("Setup" - "Screen" - "Projection") to match the method of projection being used. ("Setup" menu in **OWNER'S MANUAL**)



- Leave a space of at least 20 cm between the projector and the wall when setting up the projector near a wall.
- The customer must never carry out installation work such as suspending the projector from a ceiling themselves. (Specialist techniques and experience are required for such work. Ask your dealer for advice.)



- Turn off the power for the projector and the home theater system before making the connections.
- Check the shapes of the cable connectors and the device ports before making the connections. If you try to force a connector to fit a device port with a different shape or number of terminals, a malfunction or damage to the connector or port may result.

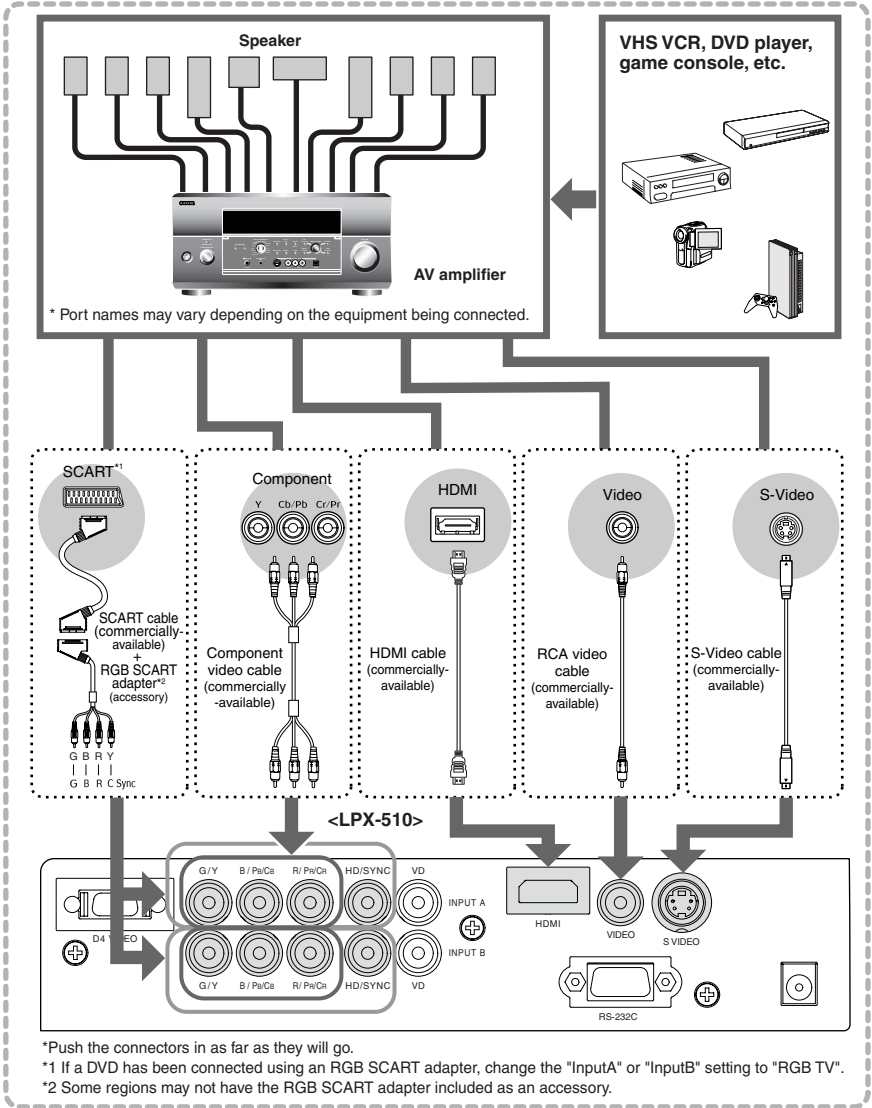

If video signals are being input to several input ports simultaneously, interference between the various signals may occur, and this may cause interference in the projected images. If this happens, turn off the power supply or disconnect the video equipment which is not currently being used.



- Turn off the power for both the projector and the computer before connecting them. If the power for either device is on at the time of connection, damage may result.
- Check the shapes of the cable connectors and the device ports before making the connections. If you try to force a connector to fit a device port with a different shape or number of terminals, damage to the connector or port may result.

The projector cannot be connected to some types of computer, or projection of images may not be possible even if actual connection is possible. Make sure that the computer you intend to use satisfies the conditions given below.

Condition 1: The computer must have a image signal output port.

Check that the computer has a port such as an RGB port, monitor port or video port which can output image signals. If the computer has a built-in monitor, or if using a laptop computer, it may not be possible to connect the computer to the projector, or alternatively you may need to purchase a separate external output port. Refer to the OWNER'S MANUAL for your computer under a heading such as "Connecting an external monitor" or similar for further details.

Condition 2: The display resolution and frequency of the computer must be listed in the "List of Supported Signal Resolutions".

Some computers may have functions for changing the output resolution. Refer to the OWNER'S MANUAL for the computer and change the setting to within a range given in the list of supported resolutions.



- You may need to purchase a separate adapter to connect the computer to the projector, depending on the shape of the computer's monitor port. Refer to the OWNER'S MANUAL for the computer for details.
- The optional Mac Adapter Set is required in order to connect the projector to a Macintosh computer.

